

Operating instructions

TransSteel 3000c Pulse

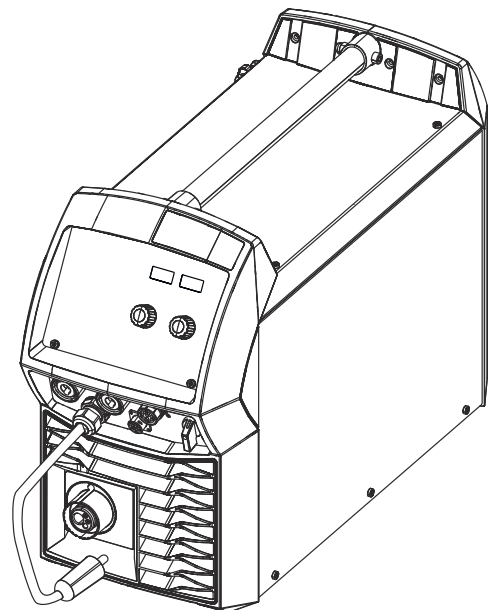

EN-US | Operating instructions



Table of contents

Safety Instructions	7
Explanation of Safety Instructions	7
General.....	7
Intended Use	8
Environmental Conditions.....	8
Obligations of the Operating Company.....	8
Obligations of Personnel.....	8
Grid Connection.....	9
Personal Protection and Protection of Others.....	9
Danger from toxic gases and vapors	9
Danger from Flying Sparks.....	10
Risks from grid current and welding current.....	10
Stray welding currents	12
EMC Device Classifications.....	12
EMC measures.....	12
EMF measures.....	13
Particular hazard areas	13
Requirement for the shielding gas.....	14
Danger from Shielding Gas Cylinders	14
Danger Posed by Shielding Gas Leak.....	15
Safety Measures at the Setup Location and During Transport.....	15
Safety Measures in Normal Operation	16
Maintenance and repair.....	16
Safety Inspection	17
Disposal.....	17
Safety symbols.....	17
Data backup.....	17
Copyright.....	17
General information	19
General.....	21
Device concept.....	21
Operating principle	21
Application areas.....	21
Warning notices on the device.....	22
Description of the warnings on the device	23
Welding processes, procedures, and welding characteristics for MIG/MAG welding.....	25
General.....	25
Brief description of MIG/MAG standard synergic welding.....	25
Brief description of MIG/MAG pulsed synergic welding.....	25
Brief description of SynchroPulse welding.....	25
System components	26
General.....	26
Safety	26
Overview	26
Operating controls and connections	27
Control Panel.....	29
General.....	29
Safety	29
Control panel.....	30
Service parameters	35
Keylock.....	36
Connections, Switches, and Mechanical Components.....	37
Front and back.....	37
Side view	38
Installation and Startup	39

Minimum equipment for welding operations	41
General.....	41
Gas-cooled MIG/MAG welding.....	41
Water-cooled MIG/MAG welding.....	41
Manual metal arc welding.....	41
TIG DC Welding.....	41
Before installation and initial operation.....	42
Safety.....	42
Intended Use.....	42
Setup regulations.....	42
Grid Connection.....	43
Connecting the Mains Cable.....	44
Stipulated mains cables and strain-relief devices.....	44
Safety.....	44
Connecting the mains cable.....	44
Fitting the strain-relief device.....	45
Fitting the strain-relief device for Canada / US.....	46
Generator-Powered Operation.....	47
Generator-powered operation.....	47
Commissioning.....	48
Safety.....	48
General.....	48
Information on system components.....	48
Assembling system components.....	49
Establishing a ground earth connection	49
Inserting/changing feed rollers.....	50
Inserting the wire spool.....	51
Installing the basket-type spool.....	52
Feed in the wire electrode.....	53
Setting the contact pressure.....	55
Adjust the brake.....	56
Design of the brake	56
Setting the date and time when starting for the first time.....	57
MIG/MAG welding	59
Power Limitation.....	61
Safety function.....	61
MIG/MAG Operating Modes.....	62
General.....	62
Symbols and explanations.....	62
2-step mode.....	63
4-step mode.....	63
Special 2-step mode	64
Special 4-step mode.....	64
Spot welding.....	65
2-step stitch welding.....	65
4-step stitch welding	66
MIG/MAG welding.....	67
Safety.....	67
Preparation.....	67
Overview	67
MIG/MAG synergic welding.....	68
MIG/MAG synergic welding.....	68
Corrections during welding.....	70
SynchroPulse welding	70
MIG/MAG Standard Manual Welding.....	72
General.....	72
Available parameters.....	72
MIG/MAG standard manual welding	72
Corrections during welding.....	73
Spot welding and stitch welding.....	74

General.....	74
Spot welding.....	74
Stitch welding.....	75
EasyJob mode.....	77
General.....	77
Saving EasyJob operating points.....	77
Retrieving EasyJob operating points.....	77
Deleting EasyJob operating points.....	77
Retrieving EasyJob operating points on the Up/Down welding torch.....	78
TIG welding	79
TIG welding.....	81
Safety.....	81
Preparation.....	81
TIG welding.....	82
Igniting the arc.....	83
Ending the welding process.....	83
Pulse welding.....	84
Applications.....	84
Operating principle.....	84
Activating pulse welding.....	85
Manual Metal Arc Welding	87
Manual Metal Arc Welding.....	89
Safety.....	89
Preparation.....	89
Manual metal arc welding.....	90
Corrections during welding.....	90
HotStart function.....	92
Anti-Stick function.....	92
Easy Documentation	93
General.....	95
General.....	95
Documented welding data.....	95
New CSV file.....	96
PDF report / Fronius signature.....	96
Activating / deactivating Easy Documentation.....	97
Activating Easy Documentation.....	97
Set the date and time.....	97
Deactivating Easy Documentation.....	98
Setup Settings	99
Setup Menu.....	101
General.....	101
Operation.....	101
Setup parameters for MIG/MAG synergic welding.....	102
Setup parameters for MIG/MAG standard manual welding.....	104
Setup parameters for MMA welding.....	105
Parameters for TIG welding.....	105
Setup Menu 2nd Level.....	107
Limitations.....	107
Operation (Setup Menu 2nd Level).....	107
Parameters for MIG/MAG synergic welding in Setup menu 2nd level.....	108
Parameters for MIG/MAG standard manual welding in Setup menu 2nd level.....	110
Parameters for manual metal arc welding in Setup menu 2nd level.....	112
Parameters for TIG welding (Setup menu 2nd level).....	113
Measuring the Welding Circuit Resistance r.....	114
General.....	114
Measuring the welding circuit resistance (MIG/MAG welding).....	114

Measuring the welding circuit resistance (MMA welding).....	115
Displaying the welding circuit Inductivity L	116
General.....	116
Displaying the welding circuit inductivity	116
Laying the hosepacks correctly.....	116
Troubleshooting and Maintenance	117
Troubleshooting	119
General.....	119
Safety	119
Displayed Service Codes	119
Displayed service codes in connection with OPT Easy Documentation.....	124
Service, maintenance and disposal	125
General.....	125
Safety	125
At every start-up.....	125
Whenever required.....	125
Every 2 Months.....	125
Every 6 Months.....	126
Disposal.....	126
Appendix	127
Average consumption values during welding.....	129
Average wire electrode consumption during MIG/MAG welding.....	129
Average shielding gas consumption during MIG/MAG welding	129
Average shielding gas consumption during TIG welding	129
Technical data.....	130
Overview with critical raw materials, year of production of the device.....	130
Special Voltage.....	130
Explanation of the term duty cycle.....	130
TransSteel 3000c Pulse TransSteel 3000c Pulse nc.....	132
Welding program tables.....	134
Welding program label on the device	134
Welding program tables for TransSteel 3000c Pulse	135
Welding program tables for TransSteel 3000c Pulse - US	137

Safety Instructions

Explanation of Safety Instructions

DANGER!

Indicates an immediate danger.

- ▶ Death or serious injury may result if appropriate precautions are not taken.

WARNING!

Indicates a possibly dangerous situation.

- ▶ Death or serious injury may result if appropriate precautions are not taken.

CAUTION!

Indicates a situation where damage or injury could occur.

- ▶ Minor injury or damage to property may result if appropriate precautions are not taken.

NOTE!

Indicates the possibility of flawed results and damage to the equipment.

General

The device has been manufactured using state-of-the-art technology and according to recognized safety standards. If used incorrectly or misused, however, it can cause

- Injury or death to the operator or a third party
- Damage to the device and other material assets belonging to the operating company
- Inefficient operation of the equipment

All persons involved in the commissioning, operation, maintenance, and servicing of the device must

- Be suitably qualified
- Have knowledge of welding
- Have completely read and followed these Operating Instructions

The Operating Instructions must always be at hand wherever the device is being used. In addition to the Operating Instructions, all applicable local rules and regulations regarding accident prevention and environmental protection must also be followed.

All safety and danger notices on the device must

- Be kept in a legible state
- Not be damaged/marked
- Not be removed
- Not be covered, pasted, or painted over

For the location of the safety and danger notices on the device, refer to the section headed "General" in the Operating Instructions for the device.

Before switching on the device, remove any faults that could compromise safety.

Your personal safety is at stake!

Intended Use

The device is to be used exclusively for its intended purpose.

The device is intended exclusively for the welding process specified on the rating plate.

Utilization for any other purpose, or in any other manner, shall be deemed to be "not in accordance with the intended purpose." The manufacturer is not responsible for any damage resulting from improper use.

Proper use also means

- Completely reading and obeying all instructions in the Operating Instructions
- Completely reading and obeying all safety instructions and danger notices
- Carrying out all the specified inspection and servicing work

Never use the device for the following applications:

- Thawing pipes
- Charging batteries
- Starting motors

The device is designed for operation in industry and business. The manufacturer shall not be liable for any damage resulting from use in a living area.

The manufacturer shall also not be liable for faulty or incorrect work results.

Environmental Conditions

Operation or storage of the device outside the stipulated area will be deemed as not in accordance with the intended purpose. The manufacturer accepts no liability for any damage resulting from improper use.

Temperature range of the ambient air:

- During operation: -10°C to +40°C (14°F to 104°F)
- During transport and storage: -20°C to +55°C (-4°F to 131°F)

Relative humidity:

- Up to 50% at 40°C (104°F)
- Up to 90% at 20°C (68°F)

Ambient air: free of dust, acids, corrosive gases or substances, etc.

Altitude above sea level: up to 2000 m (6561 ft. 8.16 in.)

Obligations of the Operating Company

- The operating company must only allow persons to work with the device if they
- Are familiar with the basic occupational safety and accident prevention regulations and are trained in handling the device
 - Have read and understood these Operating Instructions, especially the section "Safety Rules," and have confirmed this with their signature
 - Are trained according to the requirements for the work results

The safety-conscious work of the personnel must be checked regularly.

Obligations of Personnel

All persons who are assigned to work with the device must do the following before beginning the work:

- Follow the basic regulations for occupational safety and accident prevention
- Read these Operating Instructions, especially the section "Safety Rules," and confirm that they have understood and will follow them by signing

Before leaving the workplace, ensure that no personal injury or property damage can occur in one's absence.

Grid Connection Devices with a high output can influence the energy quality of the grid due to their current consumption.

This may affect a number of device types in terms of:

- connection restrictions
- criteria regarding maximum permissible grid impedance ^{*)}
- criteria regarding the minimum required short-circuit power ^{*)}

^{*)} both at the interface with the public grid

See technical data

In this case, the operator or the person using the device should check whether or not the device is allowed to be connected, where appropriate through discussion with the power supply company.

IMPORTANT! Ensure secure grounding of the grid connection!

Personal Protection and Protection of Others

You are exposed to numerous hazards while handling the device, for example:

- Flying sparks and pieces of hot metal
 - Arc radiation that poses a risk of injury to the eyes and skin
 - Hazardous electromagnetic fields that pose a risk of death for individuals with pacemakers
 - Electrical risks from grid current and welding current
 - Increased noise exposure
 - Harmful welding fumes and gases
-

Wear suitable protective clothing when dealing with the device. The protective clothing must have the following properties:

- Flame resistant
 - Insulating and dry
 - Covering the entire body and in good condition with no damage
 - Safety helmet
 - Cuffless pants
-

Protective clothing involves the following:

- Protecting the face and eyes from UV radiation, heat and flying sparks with a face guard featuring a regulation-compliant filter
 - Wearing regulation-compliant protective goggles with side protection behind the face guard
 - Wearing rigid, wet-insulating footwear
 - Protecting hands with appropriate gloves (featuring electrical insulation and thermal protection)
 - Wearing ear protection to reduce noise exposure and protect against injury
-

Keep persons, especially children, away during the operation of the devices and during the welding process. If persons are in the vicinity, however:

- Instruct them about all hazards (blinding hazard due to arcs, risk of injury from flying sparks, welding fumes hazardous to health, noise exposure, possible hazard due to grid current or welding current, etc.)
 - Provide suitable protective equipment or
 - Construct suitable protective walls and curtains.
-

Danger from toxic gases and vapors

The fumes produced during welding contain toxic gases and vapors.

Welding fumes contain substances that cause cancer, as stated in monograph 118 from the International Agency for Research on Cancer.

Use at-source extraction source and a room extraction system.
If possible, use a welding torch with an integrated extraction device.

Keep your head out of the welding fumes and gases.

Take the following precautionary measures for fumes and harmful gases:

- Do not breathe them in.
 - Extract them from the work area using appropriate equipment.
-

Ensure that there is a sufficient supply of fresh air. Ensure that there is a ventilation flow rate of at least 20 m³ per hour.

Use a welding helmet with air supply if there is insufficient ventilation.

If there is uncertainty as to whether the extraction capacity is sufficient, compare the measured toxic emission values against the permissible limit values.

The following components are factors that determine how toxic the welding fumes are:

- The metals used for the workpiece
 - Electrodes
 - Coatings
 - Cleaning agents, degreasers, and the like
 - The welding process used
-

Consult the corresponding material safety data sheets and manufacturer's instructions for the components listed above.

Recommendations for exposure scenarios, risk management measures and identifying working conditions can be found on the European Welding Association website under Health & Safety (<https://european-welding.org>).

Keep flammable vapors (such as solvent vapors) out of the arc radiation range.

When no welding is taking place, close the valve of the shielding gas cylinder or the main gas supply.

Danger from Flying Sparks

Flying sparks can cause fires and explosions.

Never undertake welding near flammable materials.

Flammable materials must be kept at least 11 meters (36 ft. 1.07 in.) from the arc or protected with a certified cover.

Keep suitable, tested fire extinguishers on hand.

Sparks and pieces of hot metal may also get into surrounding areas through small cracks and openings. Take appropriate measures to ensure that there is no risk of injury or fire.

Do not undertake welding in areas at risk of fire and explosion, or on sealed tanks, drums, or pipes if these have not been prepared in accordance with corresponding national and international standards.

Do not undertake welding on containers in which gases, fuels, mineral oils, and the like are/were stored. Residues pose a risk of explosion.

Risks from grid current and welding current

An electric shock can be fatal.

Do not touch voltage-carrying parts inside or outside the device.

During MIG/MAG welding and TIG welding, the welding wire, the wirespool, the feed rollers, as well as all pieces of metal that are in contact with the welding wire, are live.

Always place the wirefeeder on a sufficiently insulated base or use a suitable insulating wirefeeder holder.

Ensure suitable personal protection with dry temporary backing or cover with sufficient insulation against the ground potential. The temporary backing or cover must completely cover the entire area between the body and the ground potential.

All cables and leads must be secured, undamaged, insulated, and adequately dimensioned. Replace loose connections and scorched, damaged, or inadequately dimensioned cables and leads immediately.

Before every use, check power connections for secure fit by hand.

In the case of power cables with bayonet connectors, turn the power cable by at least 180° around the longitudinal axis and pretension.

Do not wrap cables or leads around your body or parts of the body.

Concerning the electrode (rod electrode, tungsten electrode, welding wire, etc.)

- Never immerse it in liquids to cool it
- Never touch it when the power source is switched on.

The open circuit voltage of a welding system may double, for example, between the electrodes of two welding systems. Touching the potentials of both electrodes at the same time may be life-threatening in some cases.

Have the grid and device supply lead regularly inspected by an electrician to ensure that the ground conductor is functioning properly.

Protection class I devices require a grid with a ground conductor and a connector system with ground conductor contact for proper operation.

Operation of the device on a grid without a ground conductor and on a socket without a ground conductor contact is only permitted if all national regulations for protective separation are observed.

Otherwise, this is considered gross negligence. The manufacturer accepts no liability for any damage resulting from improper use.

Use suitable equipment to ensure that the workpiece is sufficiently grounded if necessary.

Switch off unused devices.

When working at elevated heights, wear a safety harness to prevent falls.

Before working on the device, switch off the device and remove the grid plug.

Secure the device to prevent the grid plug from being connected and switched on again by applying a clearly legible and understandable warning sign.

After opening the device:

- Discharge all electrically charged components
- Ensure that all components are disconnected from the power supply.

If work is needed on voltage-carrying parts, bring in a second person who will switch off the main switch at the correct time.

Stray welding currents

If the following instructions are not observed, stray welding currents may occur, which pose a risk of the following:

- Fire
- Overheating of parts connected to the workpiece
- Irreparable damage to ground conductors
- Damage to the device and other electrical equipment

Ensure that the workpiece clamp is securely connected to the workpiece.

Secure the workpiece clamp as close to the spot to be welded as possible.

Position the device with sufficient insulation against electrically conductive environments, e.g., insulation against electrically conductive floors or electrically conductive mounts.

Observe the following when using power distribution boards, twin-head mounts, etc.: Even the electrode of the welding torch/electrode holder not in use carries electric potential. Ensure that there is sufficient insulation when the unused welding torch/electrode holder is stored.

In automated MIG/MAG applications, only guide the wire electrode from the welding wire drum, large spool, or wirepool to the wirefeeder with insulation.

EMC Device Classifications

Devices in emission class A:

- Are only designed for use in industrial settings
- Can cause line-bound and radiated interference in other areas

Devices in emission class B:

- Satisfy the emissions criteria for residential and industrial areas. This is also true for residential areas in which the energy is supplied from the public low-voltage grid.

EMC device classification as per the rating plate or technical data.

EMC measures

In certain cases, even though a device complies with the standard limit values for emissions, it may affect the application area for which it was designed (e.g., when there is sensitive equipment at the same location, or if the site where the device is installed is close to either radio or television receivers).

If this is the case, then the operating company is obliged to take appropriate action to rectify the situation.

Test and assess the immunity of equipment in the vicinity of the device in accordance with national and international provisions. Examples of interference-prone equipment that could be affected by the device:

- Safety devices
- Grid power lines, signal lines, and data transfer lines
- IT and telecommunications equipment
- Devices for measuring and calibrating

Supporting measures to avoid EMC problems:

1. Grid power supply
 - If electromagnetic interference occurs despite a grid connection that complies with regulations, take additional measures (e.g., use a suitable grid filter).
2. Welding power-leads
 - Keep them as short as possible
 - Route them close together (also to avoid EMF problems)
 - Route them far from other lines

3. Equipotential bonding
4. Workpiece grounding
 - If necessary, establish grounding using suitable capacitors.
5. Shield, if necessary
 - Shield other devices in the vicinity
 - Shield the entire welding installation

EMF measures

Electromagnetic fields may cause health problems that are not yet known:

- Effects on the health of persons close by, e.g., those with pacemakers and hearing aids
- Persons with pacemakers must seek advice from their doctor before staying in the immediate vicinity of the device and the welding process
- Keep distances between welding power-leads and the head/torso of the welder as great as possible for safety reasons
- Do not carry welding power-leads and hosepacks over your shoulder or wrap them around your body or body parts

Particular hazard areas

Keep hands, hair, loose clothing, and tools away from moving parts, such as:

- Fans
- Gears
- Rollers
- Shafts
- Wirespools and welding wires

Do not reach into rotating gears of the wire drive or into rotating drive parts.

Covers and side panels must only be opened/removed during maintenance and repair work.

During operation

- Ensure that all covers are closed, and all side parts have been mounted properly.
- Keep all covers and side parts closed.

The protrusion of welding wire from the welding torch represents a high risk of injury (cuts to the hand, facial and eye injuries, etc.).

Therefore, always hold the welding torch away from the body (devices with wirefeeder) and use suitable protective goggles.

Do not touch the workpiece during or after welding – risk of burns.

Slag may fly off cooling workpieces. Therefore, also wear regulation-compliant protective equipment when reworking workpieces and ensure that other persons are sufficiently protected.

Leave the welding torch and other parts with a high operating temperature to cool before working on them.

Special regulations apply in areas at risk of fire or explosion – follow the appropriate national and international regulations.

Power sources for work in areas with increased electrical hazard (e.g., boilers) must be labeled with the symbol (Safety). However, the power source may not be located in such areas.

Risk of scalding due to leaking coolant. Switch off the cooling unit before disconnecting connections for the coolant supply or return.

When handling coolant, observe the information on the coolant safety data sheet. The coolant safety data sheet can be obtained from your service center or via the manufacturer's website.

Only use suitable load-carrying equipment from the manufacturer to transport devices by crane.

- Attach chains or ropes to all designated attachments of the suitable load-carrying equipment.
 - Chains or ropes must be the smallest angle possible from vertical.
 - Remove gas cylinder and wirefeeder (MIG/MAG and TIG devices).
-

In the event of crane attachment of the wirefeeder during welding, always use a suitable, insulating wirefeeder hoisting attachment (MIG/MAG and TIG devices).

If the device is equipped with a carrier belt or handle, then this is used exclusively for transport by hand. The carrier belt is not suitable for transport by crane, counterbalanced lift truck, or other mechanical lifting tools.

All lifting equipment (belts, buckles, chains, etc.), which is used in association with the device or its components, must be checked regularly (e.g., for mechanical damage, corrosion, or changes due to other environmental influences). The test interval and scope must at least comply with the respective valid national standards and guidelines.

There is a risk of colorless, odorless shielding gas escaping without notice if an adapter is used for the shielding gas connection. Use suitable Teflon tape to seal the thread of the shielding gas connection adapter on the device side before installation.

Requirement for the shielding gas

Especially with ring lines, contaminated shielding gas can cause damage to equipment and reduce welding quality.

Meet the following requirements regarding shielding gas quality:

- Solid particle size < 40 µm
 - Pressure condensation point < -20 °C
 - Max. oil content < 25 mg/m³
-

Use filters if necessary.

Danger from Shielding Gas Cylinders

Shielding gas cylinders contain compressed gas and may explode if damaged. Shielding gas cylinders are an integral part of the welding equipment, so they must be handled very carefully.

Protect shielding gas cylinders with compressed gas from excessive heat, mechanical impact, slag, open flames, sparks, and arcs.

Mount the shielding gas cylinders vertically and secure them in accordance with instructions so they cannot fall over.

Keep shielding gas cylinders away from welding or other electrical circuits.

Never hang a welding torch on a shielding gas cylinder.

Never touch a shielding gas cylinder with an electrode.

Risk of explosion: Never weld on a compressed shielding gas cylinder.

Always use suitable shielding gas cylinders for the application in question and the correct matching accessories (controller, hoses, and fittings, etc.) Only use shielding gas cylinders and accessories that are in good condition.

If a valve on a shielding gas cylinder is open, turn your face away from the outlet.

When no welding is taking place, close the valve of the shielding gas cylinder.

Leave the cap on the valve of the shielding gas cylinder when the cylinder is not connected.

Follow the manufacturer's instructions and applicable national and international provisions for shielding gas cylinders and accessories.

Danger Posed by Shielding Gas Leak

Risk of asphyxiation due to uncontrolled shielding gas leak

Shielding gas is colorless and odorless and may suppress the oxygen in the ambient air in the event of leakage.

- Ensure there is a sufficient supply of fresh air with a ventilation flow rate of at least 20 m³ per hour.
- Please observe the safety and maintenance information for the shielding gas cylinder or the main gas supply.
- When no welding is taking place, close the valve of the shielding gas cylinder or the main gas supply.
- Always check the shielding gas cylinder or main gas supply for uncontrolled gas leakage before each start-up.

Safety Measures at the Setup Location and During Transport

A toppling device can be deadly! Set up the device securely on an even, solid surface

- The maximum permitted tilt angle is 10°.

Special regulations apply in areas at risk of fire or explosion

- Follow the appropriate national and international regulations.

Use instructions and checks within the company to ensure that the vicinity of the workplace is always clean and organized.

Only set up and operate the device in accordance with the protection class shown on the rating plate.

When setting up the device, ensure that there is an all-round clearance of 0.5 m (1 ft. 7.69 in.) to allow cooling air to circulate unhindered.

Take care to ensure that the applicable national and regional guidelines and accident prevention regulations are observed when transporting the device, especially guidelines concerning hazards during transport and shipment.

Do not lift or transport any active devices. Switch off devices before transport or lifting.

Before transporting the device, completely drain the coolant and dismantle the following components:

- wirefeeder
- wirespool
- shielding gas cylinder

It is essential to conduct a visual inspection of the device to check for damage after it has been transported but before commissioning. Have any damage repaired by trained service technicians before commissioning the device.

**Safety Measures
in Normal Oper-
ation**

Only operate the device when all safety devices are fully functional. If the safety devices are not fully functional, there is a danger of:

- Injury or death to the operator or a third party
- Damage to the device and other material assets belonging to the operating company
- Inefficient operation of the device

Safety devices that are not fully functional must be repaired before the device is switched on.

Never bypass or disable safety devices.

Before switching on the device, ensure that no one can be put in danger.

The device must be examined at least once a week for externally detectable damage and functionality of the safety devices.

Always secure the shielding gas cylinder well and remove before transporting by crane.

Only the original coolant from the manufacturer is suitable for use in our devices due to its properties (electrical conductivity, anti-freeze, material compatibility, flammability, etc.)

Only use appropriate original coolant from the manufacturer.

Do not mix original coolant from the manufacturer with other coolants.

Only connect system components from the manufacturer to the cooling unit circuit.

If there is damage due to use of other system components or other coolants, the manufacturer accepts no liability for this and all warranty claims are forfeited.

Cooling Liquid FCL 10/20 is not flammable. The ethanol-based coolant is flammable in certain conditions. Only transport the coolant in closed original containers and keep away from sources of ignition.

Properly dispose of used coolant according to national and international regulations. The coolant safety data sheet can be obtained from your service center or via the manufacturer's website.

When the system is cool, always check the coolant level before starting welding.

**Maintenance and
repair**

It is impossible to guarantee that bought-in parts are designed and manufactured to meet the demands made of them, or that they satisfy safety requirements.

- Use only original spare and wearing parts (also applies to standard parts).
- Do not carry out any modifications, alterations, etc. to the device without the manufacturer's consent.
- Components that are not in perfect condition must be replaced immediately.
- When ordering, please give the exact designation and part number as shown in the spare parts list, as well as the serial number of your device.

The housing screws provide the ground conductor connection for earthing the housing parts.

Only use original housing screws in the correct number and tightened to the specified torque.

Safety Inspection	<p>The manufacturer recommends that a safety inspection of the device be performed at least every 12 months.</p>
	<hr/> <p>The manufacturer recommends calibrating power sources within the same 12-month interval.</p>
	<hr/> <p>A safety inspection by a certified electrician is recommended:</p> <ul style="list-style-type: none">- After changes- After alterations- After repair, care, and maintenance- At least every 12 months
	<hr/> <p>For the safety inspection, follow the appropriate national and international standards and guidelines.</p>
	<hr/> <p>You can obtain more information about the safety inspection and calibration from your service center. The service center will provide the necessary documents upon request.</p>
<hr/>	
Disposal	<p>To comply with European directives and national law, waste electrical and electronic equipment must be collected separately and sent for environmentally-friendly recycling. Used devices must be returned to a distributor or an approved collection and recycling facility in your area. Proper disposal of used devices promotes the sustainable recycling of material resources. Ignoring this may have potentially adverse effects on the environment and your health.</p>
	<p>Packaging materials Materials collected separately. Check the regulations in your area. Reduce the volume of cardboard.</p>
<hr/>	
Safety symbols	<p>Devices with the CE label satisfy the essential requirements of the low-voltage and electromagnetic compatibility directive (e.g., relevant product standards of the EN 60974 series).</p>
	<p>Fronius International GmbH declares that the device complies with Directive 2014/53/EU. The full text of the EU Declaration of Conformity is available on the following website: http://www.fronius.com</p>
	<hr/> <p>Devices marked with the CSA test mark satisfy the requirements of the relevant standards for Canada and the USA.</p>
<hr/>	
Data backup	<p>The user is responsible for backing up any changes made to the factory settings. The manufacturer accepts no liability for any deleted personal settings.</p>
<hr/>	
Copyright	<p>Copyright of these Operating Instructions remains with the manufacturer.</p>
	<hr/> <p>Text and illustrations were accurate at the time of printing. Fronius reserves the right to make changes. The contents of the Operating Instructions shall not provide the basis for any claims whatsoever on the part of the purchaser. If you have any suggestions for improvement, or can point out any mistakes that you have found in the Operating Instructions, we will be most grateful for your comments.</p>

General information

Device concept

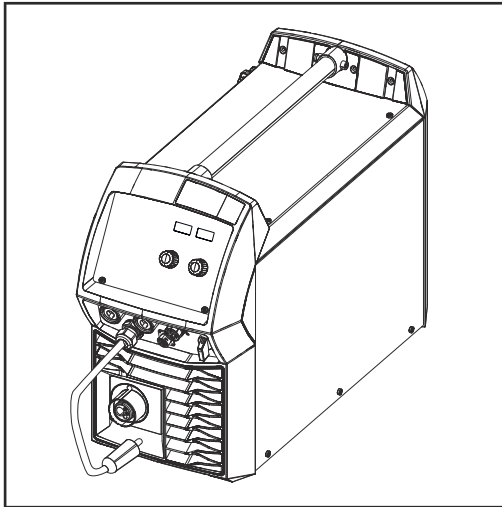

The TransSteel (TSt) 3000c Pulse power source is a fully digitized, micro-processor-controlled inverter power source.

A modular design and ability to easily extend the system guarantee a high degree of flexibility. The device is designed for the following welding processes:

- MIG/MAG pulse welding
- MIG/MAG standard synergic welding
- TIG welding
- Manual metal arc welding

The device has a "Power limitation" safety feature. This means that the power source can be operated at the power limit without compromising process safety. For details, refer to the "Welding operations" chapter.

Operating principle

The central control and regulation unit of the power sources is coupled with a digital signal processor. The central control and regulation unit and signal processor control the entire welding process.

During the welding process, the actual data is measured continuously and the device responds immediately to any changes. Control algorithms ensure that the desired target state is maintained.

This results in:

- A precise welding process
- A high degree of reproducibility on all results
- Excellent weld properties.

Application areas







The TransSteel 3000c Pulse is used in trade and industry for manual applications with classical steel and galvanized sheet metal.

The power source is designed for:

- Mechanical and equipment engineering
- Steel construction
- Plant and container construction
- Metal and portal construction
- Rail vehicle construction
- Metalworking trades

Warning notices on the device

There are warning notices and safety symbols on the power sources. These warning notices and safety symbols must not be removed or painted over. They warn against incorrect operation, as this may result in serious injury and property damage.

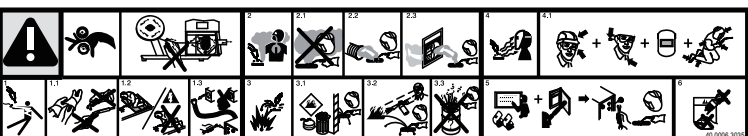
⚠ WARNING			ARC RAYS can burn eyes and skin; NOISE can damage hearing. <ul style="list-style-type: none"> ● Wear welding helmet with correct filter. ● Wear correct eye, ear and body protection. 	Read American National Standard Z49.1, "Safety in Welding and Cutting" From American Welding Society, 550 N.W. LeJeune Rd., Miami, FL 33126; OSHA Safety and Health Standards, 29 CFR 1910, from U.S. Government Printing Office, Washington, DC 20402. CSA, W117-2, M87, Code for Safety in Welding and Cutting. 42.0409.5074
Do not Remove, Destroy, Or Cover This Label			EXPLODING PARTS can injure. <ul style="list-style-type: none"> ● Failed parts can explode or cause other parts to explode when power is applied. ● Always wear a face shield and long sleeves when servicing. 	
	ELECTRIC SHOCK can kill. <ul style="list-style-type: none"> ● Always wear dry insulating gloves. ● Insulate yourself from work and ground. ● Do not touch live electrical parts. ● Disconnect input power before servicing. ● Keep all panels and covers securely in place. 		ELECTRIC SHOCK can kill; SIGNIFICANT DC VOLTAGE exists after removal of input power <ul style="list-style-type: none"> ● Always wait 60 seconds after power is turned off before working on unit. ● Check input capacitor voltage, and be sure it is near 0 before touching parts. 	
	FUMES AND GASES can be hazardous. <ul style="list-style-type: none"> ● Keep your head out of the fumes. ● Ventilate area, or use breathing device. ● Read Material Safety Data Sheets (MSDSs) and manufacturer's instructions for materials used. 	⚠ AVERTISSEMENT		
	WELDING can cause fire or explosion. <ul style="list-style-type: none"> ● Do not weld near flammable material. ● Watch for fire: keep extinguisher nearby. ● Do not locate unit over combustible surfaces. ● Do not weld on closed containers. 		UN CHOC ELECTRIQUE peut etre mortel. SOUDAGE A L'ARC peut etre hasardeux. <ul style="list-style-type: none"> ● Lire le manuel d' instructions avant utilisation. ● Ne pas installer sur une surface combustible. ● Les fils de soudage et pieces conductrices peuvent etre a la tension de soudage. 	

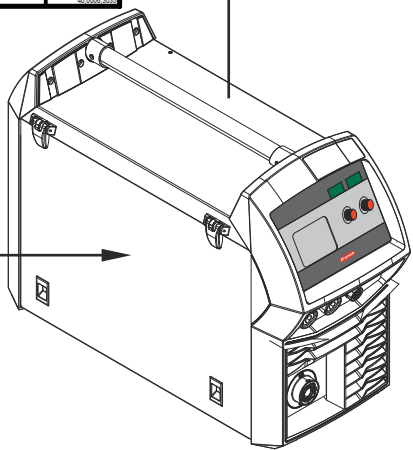

inside

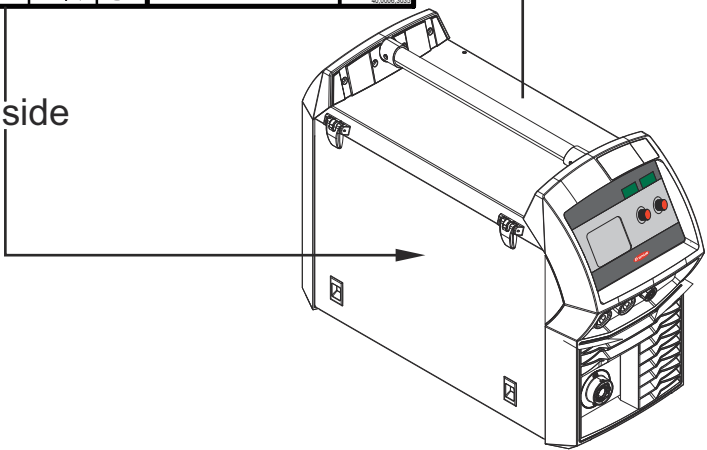



Welding is dangerous. The following basic requirements must be met:

- Adequate welding qualifications
- Appropriate protective equipment
- Exclusion of unauthorized persons



Do not use the functions described here until you have fully read and understood the following documents:

- These Operating Instructions
- All system component Operating Instructions, especially the safety rules

Description of the warnings on the device

Warning notices are attached to the device for certain device versions.

The arrangement of the symbols may vary.

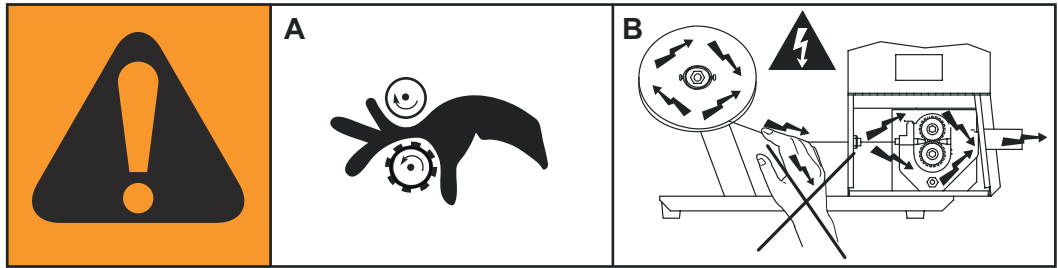

! Warning! Caution!
The symbols represent possible dangers.

A Drive rollers can injure fingers.

B The welding wire and drive parts are under welding voltage during operation.
 Keep hands and metal objects away!

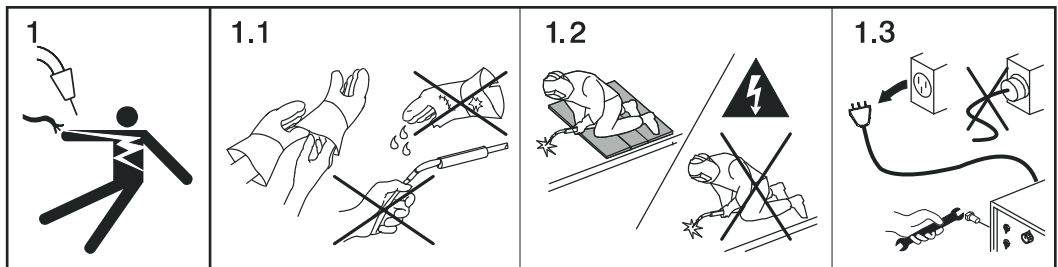

1. An electric shock can be fatal.

1.1 Wear dry, insulating gloves. Do not touch the wire electrode with bare hands. Do not wear wet or damaged gloves.

1.2 Use a base that is insulated from the floor and work area to protect against electric shock.

1.3 Before working on the device, switch off the device and remove the mains plug or disconnect the power supply.

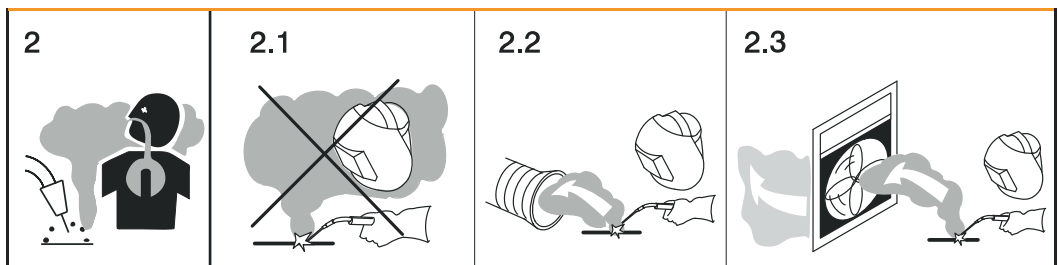

2. Inhalation of welding fumes can be harmful to health.

2.1 Keep your face away from any welding fumes.

2.2 Use forced-air ventilation or local extraction to remove welding fumes.

2.3 Remove welding fumes with a fan.

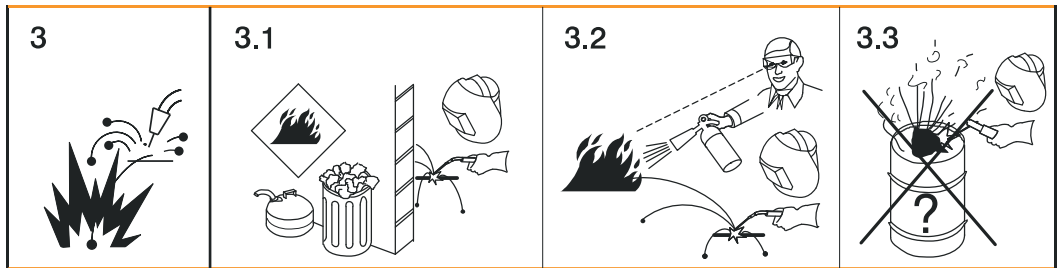

3. Welding sparks can cause an explosion or fire.

3.1 Keep flammable materials away from the welding process. Do not perform welding near flammable materials.

3.2 Welding sparks can cause a fire. Have fire extinguishers ready. If necessary, have a supervisor ready who can operate the fire extinguisher.

3.3 Do not weld on drums or closed containers.

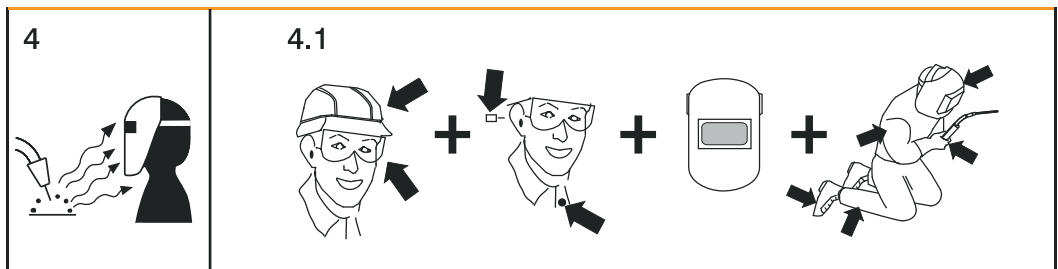

4. Arc rays can burn the eyes and injure the skin.

4.1 Wear headgear and protective goggles. Use ear protection and wear a shirt collar with button. Use a welding helmet with the correct tinting. Wear suitable protective clothing over the entire body.

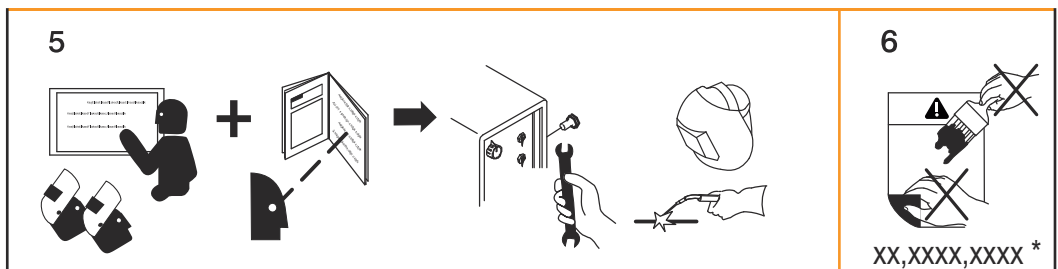

5. Before working on the machine or welding: undertake training on the device and read the instructions!

6. Do not remove or paint over the sticker with the warnings.

* Manufacturer order number of the sticker

Welding processes, procedures, and welding characteristics for MIG/MAG welding

General	In order to process a wide range of materials effectively, various welding processes, procedures, and welding characteristics are available on the power source.
Brief description of MIG/MAG standard synergic welding	<p>MIG/MAG standard synergic</p> <p>MIG/MAG standard synergic welding is a MIG/MAG welding process covering the entire power range of the power source with the following arc types:</p> <p>Dip transfer arc Droplet transfer occurs in the lower power range during the short circuit.</p> <p>Intermediate arc The droplet increases in size at the end of the wire electrode and is transferred in the mid power range during the short circuit.</p> <p>Spray arc A short circuit-free transfer of material in the high power range.</p>
Brief description of MIG/MAG pulsed synergic welding	<p>MIG/MAG pulsed synergic</p> <p>MIG/MAG pulsed synergic welding is a pulsed arc process with a controlled material transfer.</p> <p>In the base current phase, the energy input is reduced to such an extent that the arc barely burns steadily and the surface of the workpiece is preheated. In the pulsing current phase, an accurately timed current pulse guarantees a precise detachment of the weld material droplet.</p> <p>This principle guarantees low-spatter welding and precise operation throughout the entire power range.</p>
Brief description of SynchroPulse welding	<p>SynchroPulse is available for the standard synergic and pulsed synergic processes.</p> <p>The cyclic change of the welding power between two operating points with SynchroPulse achieves a finely rippled weld appearance and a non-continuous heat input.</p>

System components

General

The power sources can be operated with various system components and options. This makes it possible to optimize procedures and to simplify machine handling and operation, depending on the field of application for the power source.

Safety

WARNING!

Danger from incorrect operation and work that is not carried out properly.

This can result in serious personal injury and damage to property.

- ▶ All the work and functions described in this document must only be carried out by technically trained and qualified personnel.
- ▶ Read and understand this document in full.
- ▶ Read and understand all safety rules and user documentation for this equipment and all system components.

Overview

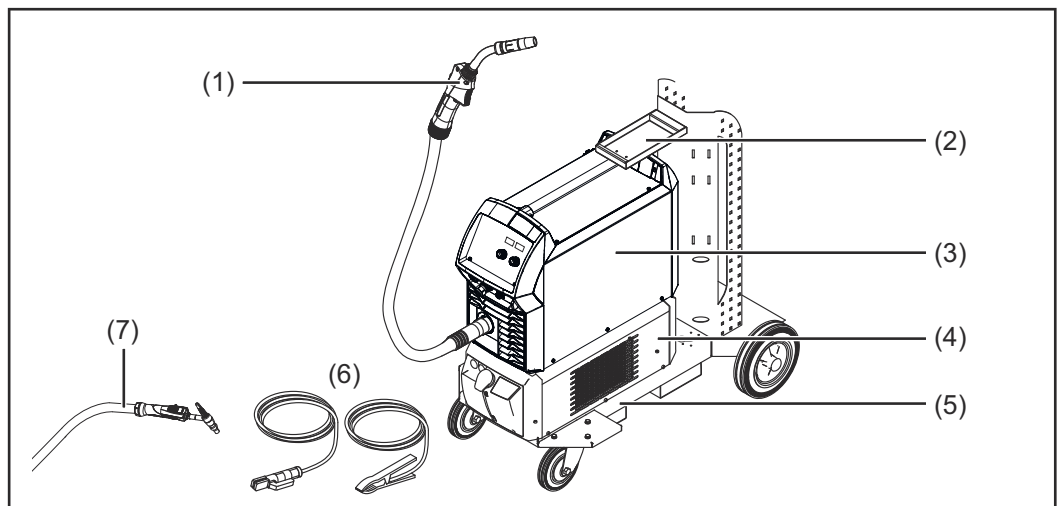

- (1) MIG/MAG welding torch
- (2) Stabilization of the gas cylinder holder
- (3) Power source
- (4) Cooling unit
- (5) Trolley with gas cylinder holder
- (6) Grounding and electrode cable
- (7) TIG welding torch

Operating controls and connections

Control Panel

General

The functions are all arranged in a logical way on the control panel. The individual parameters required for welding can be

- Selected by means of buttons
- Changed using buttons or the selection dial
- Shown on the digital display during welding.

Due to the synergic function, all other parameters are also adjusted if a single parameter is changed.

NOTE!

Because of software updates, certain functions may be available for your device but not described in these Operating Instructions or vice versa.

In addition, individual figures may also differ slightly from the operating elements of your device. However, the function of these operating elements is identical.

Safety



WARNING!

Danger from incorrect operation and work that is not carried out properly.

This can result in serious personal injury and damage to property.

- ▶ All the work and functions described in this document must only be carried out by technically trained and qualified personnel.
 - ▶ Read and understand this document in full.
 - ▶ Read and understand all safety rules and user documentation for this equipment and all system components.
-

Control panel

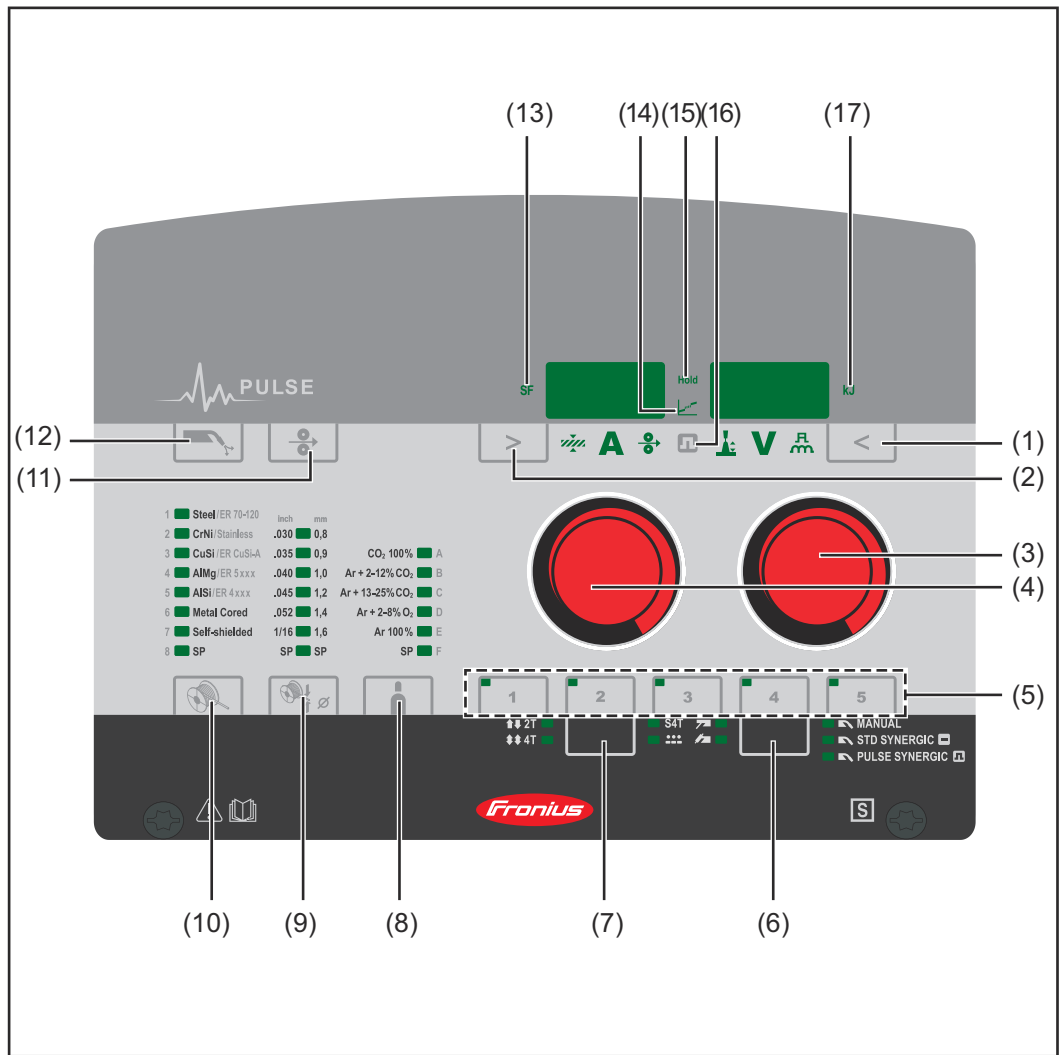

No. Function

- (1) **"Parameter selection" button (right)**
 a) for selecting the following parameters



Arc length correction

For correcting the arc length



Welding voltage in V *)

Before welding begins, the device automatically displays a standard value based on the programmed parameters. The actual value is displayed during welding.



Pulse / arc-force dynamic correction

For continuously correcting the droplet detachment force in MIG/MAG pulsed synergic welding

- ... reduced droplet detachment force
- 0 ... neutral droplet detachment force
- + ... increased droplet detachment force

For influencing the short-circuiting dynamic at the instant of droplet transfer in MIG/MAG standard synergic welding, MIG/MAG standard manual welding, and manual metal arc welding

- ... harder and more stable arc
- 0 ... neutral arc
- + ... soft and low-spatter arc

b) for changing parameters in the Setup menu

(2) "Parameter selection" button (left)

a) for selecting the following parameters



Sheet thickness

Sheet thickness in mm or in.

If the welding current to be selected is not known, it is sufficient to enter the sheet thickness. The required welding current and any other parameters marked with *) will then be adjusted automatically.



Welding current *)

Welding current in A

Before welding begins, the device automatically displays a standard value based on the programmed parameters. The actual value is displayed during welding.



Wire speed *)

Wire speed in m/min or ipm.

b) for changing parameters in the Setup menu

(3) Selection dial (right)

For changing the arc length correction, welding voltage, and arc-force dynamic parameters

For changing parameters in the Setup menu

(4) Selection dial (left)

For changing the sheet thickness, welding current, and wire speed parameters

For selecting parameters in the Setup menu

(5) EasyJob save buttons

For saving up to 5 operating points

(6) "Process" button **)

For selecting the welding process



MIG/MAG standard manual welding



MIG/MAG standard synergic welding



MIG/MAG pulsed synergic welding



TIG welding



Manual metal arc welding

(7) "Mode" button

For selecting the operating mode



2-step mode



4-step mode



Special 4-step mode



Spot welding/stitch welding

-
- (8) "Shielding gas" button**
 For selecting the shielding gas used. The SP parameter is reserved for additional shielding gases.
- When the shielding gas is selected, the LED behind the corresponding shielding gas lights up.
-
- (9) "Wire diameter" button**
 For selecting the wire diameter used. The SP parameter is reserved for additional wire diameters.
- When the wire diameter is selected, the LED behind the corresponding wire diameter lights up.
-
- (10) "Material" button**
 For selecting the filler metal used. The SP parameter is reserved for additional materials.
- When the material type is selected, the LED behind the corresponding filler metal lights up.
-
- (11) "Wire threading" button**
 Press and hold the button:
 Gasless wire threading into the torch hosepack
- While the button is being held, the wire drive operates at feeder inching speed.
-
- (12) Gas-test button**
 For setting the required gas volume on the gas pressure regulator.
- Tap the button once: shielding gas flows out
 Tap the button again: shielding gas flow stops
- If the Gas-test button is not tapped again, the shielding gas flow will stop after 30 s.
-
- (13) SF - spot/stitch/SynchroPulse welding indicator**
- Lights up if a value is set for the spot welding/stitch welding time (SPt) setup parameter when spot welding or stitch welding mode is activated
 - Lights up if a value is set for the Frequency (F) setup parameter when the MIG/MAG synergic welding process is activated.
-
- (14) Intermediate arc indicator**
 A spatter-prone "intermediate arc" occurs between the dip transfer arc and the spray arc. The intermediate arc indicator lights up to alert you to this critical area.
-
- (15) HOLD indicator**
 At the end of each welding operation, the actual values for welding current and welding voltage are stored - the "HOLD" indicator lights up.

(16) Pulse indicator

Lights up when the MIG/MAG pulsed synergic welding process is selected

(17) Real Energy Input

For displaying the energy applied during the welding operation.

The Real Energy Input indicator must be activated in level 2 of the Setup menu – EnE parameter. The value continuously rises during welding in line with the permanently increasing energy input. The final value is stored after the end of welding until welding starts again or the power source is switched back on - the HOLD indicator lights up.

- *) During the MIG/MAG standard synergic welding process and MIG/MAG pulsed synergic welding process, if one of these parameters is selected, then the synergic function ensures that all other parameters, including the welding voltage parameter, are adjusted automatically.

- **) In conjunction with the VRD option, the indicator of the currently selected welding process is also used as status indicator:
 - The indicator lights up continuously: the voltage reduction (VRD) is active and limits the output voltage to less than 35 V.
 - The indicator flashes as soon as a welding operation occurs, which can cause the output voltage to be greater than 35 V.

Service parameters

Various service parameters can be retrieved by pressing the "Parameter selection" buttons at the same time.

Opening the display

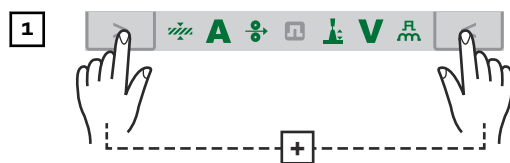

The first parameter "Firmware version" will be displayed, e.g., "1.00 | 4.21"

Selecting parameters



Use the "Mode" and "Process" buttons or the left-hand selection dial to select the required setup parameter

Available parameters

> [Icons: A, V, M] <	Explanation
Example: 1.00 4.21	Firmware version
Example: 2 491	Welding program configuration
Example: r 2 290	Number of the currently selected welding program
Example: 654 32.1 = 65,432.1 hours = 65,432 hours 6 mins	Indicates the actual arc time since first use Note: The arc time indicator is not suitable as a basis for calculating hiring fees or for warranty purposes, etc.
Example: iFd 0.0	Motor current for wire drive in A The value changes as soon as the motor is running.
2nd	2. menu level for service technicians

Keylock

A keylock can be selected to prevent the settings from being inadvertently changed on the control panel. As long as the keylock is active:

- Settings cannot be adjusted on the control panel
- Only parameter settings can be retrieved
- Any assigned "Save" button can be retrieved provided that an assigned "Save" button was selected when the keylock was enabled

Activating/deactivating the keylock:

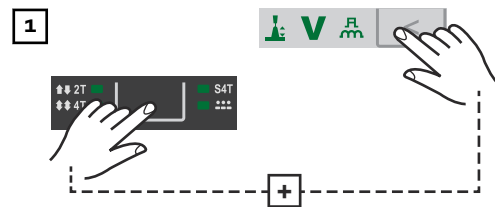

Keylock activated:

The message "CLO | SEd" appears on the displays.

Keylock deactivated:

The message "OP | En" appears on the displays.

The keylock can also be activated and deactivated using the keylock switch option.

Connections, Switches, and Mechanical Components

Front and back

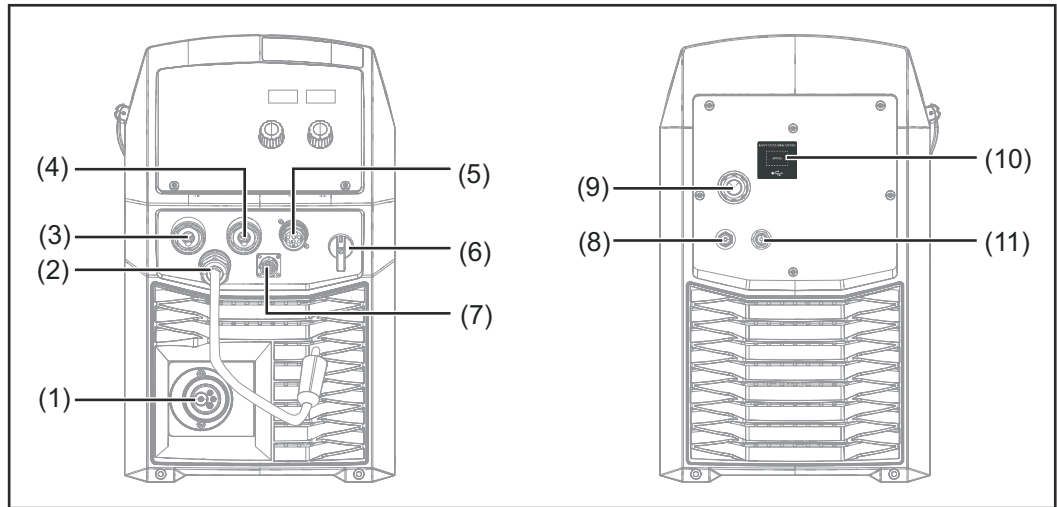

-
- (1) Welding torch connection**
For connecting the welding torch
-
- (2) Polarity reverser**
For selecting the welding potential on the MIG/MAG welding torch
-
- (3) (-) Current socket with bayonet latch**
Used for
- Connecting the grounding cable or polarity reverser for MIG/MAG welding (depending on the wire electrode used)
 - Connecting the electrode cable or grounding cable for manual metal arc welding (depending on the type of electrode used)
 - Connecting the TIG welding torch
-
- (4) (+) Current socket with bayonet latch**
Used for
- Connecting the polarity reverser or grounding cable for MIG/MAG welding (depending on the wire electrode used)
 - Connecting the electrode cable or grounding cable for manual metal arc welding (depending on the type of electrode used)
 - Connecting the grounding cable for TIG welding
-
- (5) LocalNet connection**
Standardized connection for remote control
-
- (6) Power switch**
For switching the power source on and off
-
- (7) TMC connection (TIG Multi Connector)**
For connecting the TIG welding torch
-
- (8) MIG/MAG shielding gas connection socket**
For the shielding gas supply to the welding torch connection (1)
-
- (9) Mains cable with strain relief**
Not prefitted on all models

(10) EASY DOCUMENTATION label

(11) TIG shielding gas connection socket

For the shielding gas supply for the (-) current socket (3)

Side view

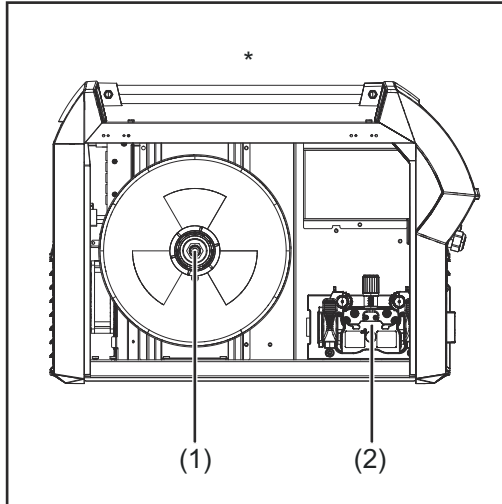

No. Function

(1) Wire spool holder with brake
For holding standard wire spools with a max. diameter of 300 mm (11.81 in.) and a max. weight of 19 kg (41.89 lbs.)

(2) 4-roller drive

* Side panel not shown

Installation and Startup

Minimum equipment for welding operations

General

Depending on the welding process, a minimum level of equipment is required to work with the power source.
The following describes the welding processes and the corresponding minimum equipment for welding operations.

Gas-cooled MIG/MAG welding

- Power source
 - Grounding cable
 - Gas-cooled MIG/MAG welding torch
 - Gas connection (shielding gas supply)
 - Wire electrode
-

Water-cooled MIG/MAG welding

- Power source
 - Cooling unit including coolant
 - Grounding cable
 - Water-cooled MIG/MAG welding torch
 - Gas connection (shielding gas supply)
 - Wire electrode
-

Manual metal arc welding

- Power source
 - Grounding cable
 - Electrode holder
 - Rod electrodes
-

TIG DC Welding

- Power source
- Grounding cable
- TIG welding torch with or without rocker switch
- Gas connection (shielding gas supply)
- Filler metal depending on application

Before installation and initial operation

Safety

WARNING!

Danger from incorrect operation and work that is not carried out properly.

This can result in serious personal injury and damage to property.

- ▶ All the work and functions described in this document must only be carried out by technically trained and qualified personnel.
 - ▶ Read and understand this document in full.
 - ▶ Read and understand all safety rules and user documentation for this equipment and all system components.
-

WARNING!

Danger from electrical current.

This can result in serious personal injury and damage to property.

- ▶ Before starting work, switch off all devices and components involved, and disconnect them from the grid.
 - ▶ Secure all devices and components involved so they cannot be switched back on.
 - ▶ After opening the device, use a suitable measuring instrument to check that electrically charged components (such as capacitors) have been discharged.
-

Intended Use

The power source is only intended for MIG/MAG, MMA and TIG welding. Any other use is deemed to be "not in accordance with the intended purpose." The manufacturer shall not be liable for any damage resulting from such improper use.

Intended use also means:

- Following all instructions in the Operating Instructions
 - Carrying out all the specified inspection and maintenance work
-

Setup regulations

The device has been tested according to degree of protection IP 23. This means:

- Protection against penetration by solid foreign bodies with diameters > 12 mm (0.49 in.)
- Protection against spraywater at any angle up to 60° from the vertical

The device can be set up and operated outdoors in accordance with degree of protection IP 23.

Direct moisture (e.g., from rain) must be avoided.

WARNING!

Danger from machines toppling over or falling.

This can result in serious personal injury and damage to property.

- ▶ Set up the device securely on an even, solid surface.
 - ▶ Check all screw connections are tightly fastened after installation.
-

⚠ WARNING!**Danger of electrical current due to electrically conductive dust in the device.**

This can result in severe personal injury and damage to property.

- ▶ Only operate the device if an air filter is fitted. The air filter is a very important safety device for achieving IP 23 protection.

The ventilation channel is a very important safety device. When selecting the setup location, ensure that the cooling air can enter or exit unhindered through the vents on the front and back. Any electrically conductive dust (e.g., from grinding work) must not be allowed to be sucked into the device.

Grid Connection

The devices are designed for the grid voltage stated on the rating plate. If the mains cable or mains plug has not been attached to your version of the appliance, these must be installed according to national standards. Fuse protection for the grid lead can be found in the technical data.

⚠ CAUTION!**Danger due inadequately dimensioned electrical installations.**

This can lead to serious damage

- ▶ The grid lead and its fuse protection should be designed to suit the existing power supply.
The technical data on the rating plate should be followed.

Connecting the Mains Cable

Stipulated mains cables and strain-relief devices

The following mains cables are required to operate the power source:

Europe:

Cable cross-section 4G2.5

USA/Canada:

Cable cross-section AWG 12, extra-hard usage

Depending on the version, a strain-relief device corresponding to the cable cross-section is fitted on the power source.

The item numbers of the different cables can be found in the Spare Parts List.

Safety

WARNING!

Danger from work that is not carried out properly.

This can result in severe personal injury and damage to property.

- ▶ The work described below may only be performed by trained specialist personnel.
 - ▶ Follow national standards and guidelines.
-

CAUTION!

Danger from improperly prepared mains cable.

Short circuits and damage to property may result.

- ▶ Fit ferrules to all phase conductors and the ground conductor of the stripped mains cable.
-

Connecting the mains cable

If no mains cable is connected, a mains cable that is suitable for the connection voltage must be fitted before commissioning.

The ground conductor should be approx. 10 - 15 mm (0.4 - 0.6 in.) longer than the phase conductors.

A graphic representation of the mains cable connection is provided in the following sections for fitting the strain-relief device. To connect the mains cable, proceed as follows:

- 1** Remove the side panel of the device
- 2** Push in the mains cable so that the ground conductor and phase conductor can be properly connected to the block terminal.
- 3** Fit a ferrule to the ground conductor and phase conductor
- 4** Connect the ground conductor and phase conductor to the block terminal
- 5** Secure the mains cable with a strain-relief device
- 6** Fit the side panel of the device

Fitting the strain-relief device

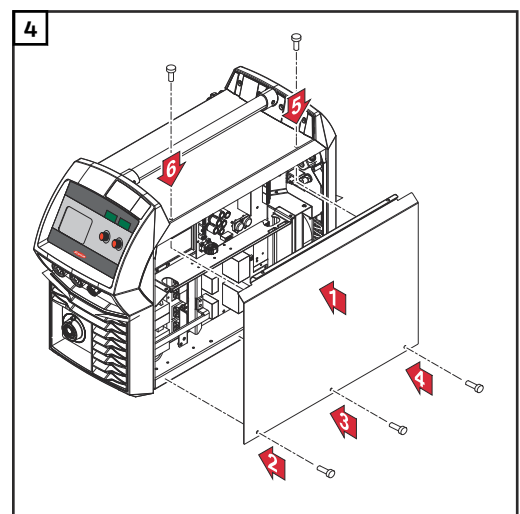
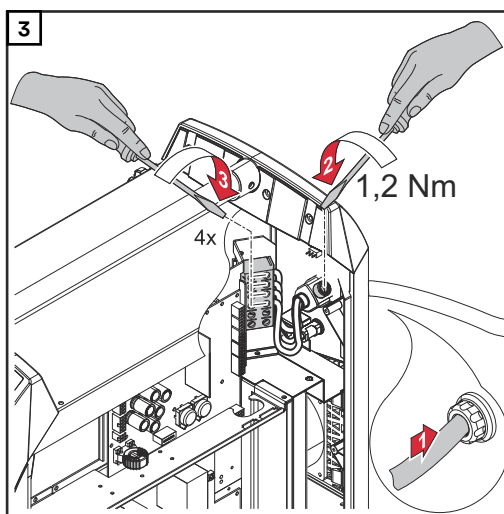
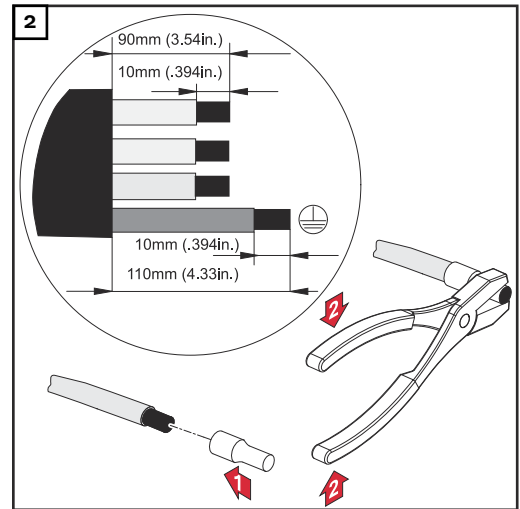
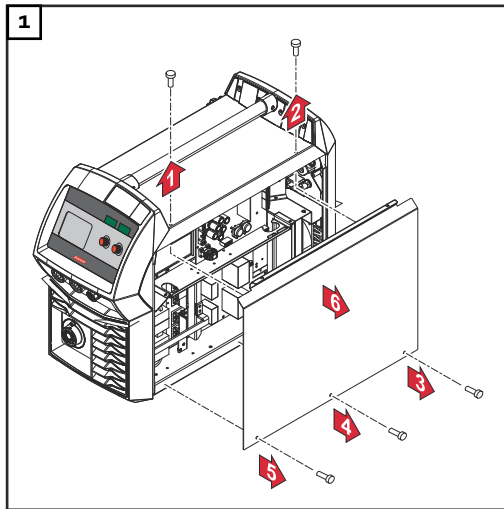

IMPORTANT! Tie the phase conductors near the block terminal using cable ties.

Fitting the strain-relief device for Canada / US

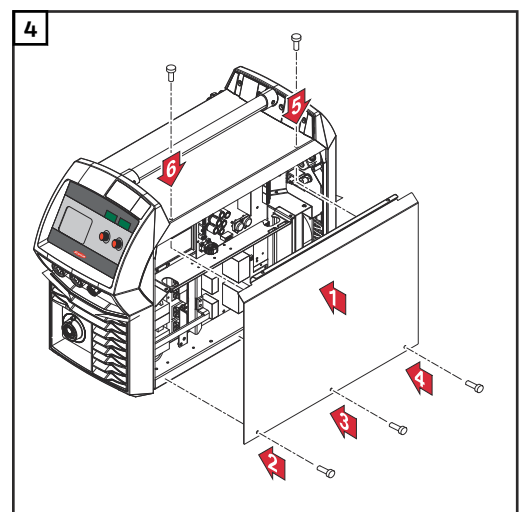
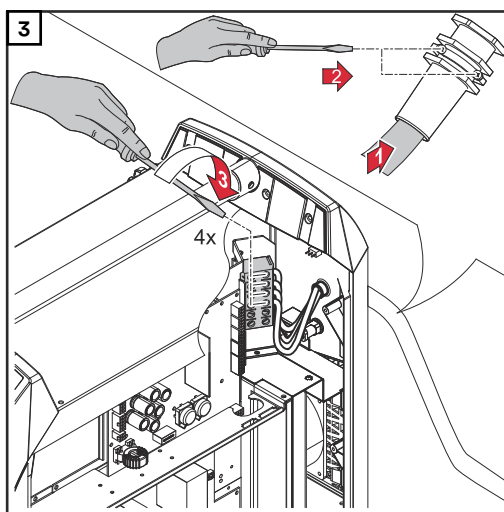
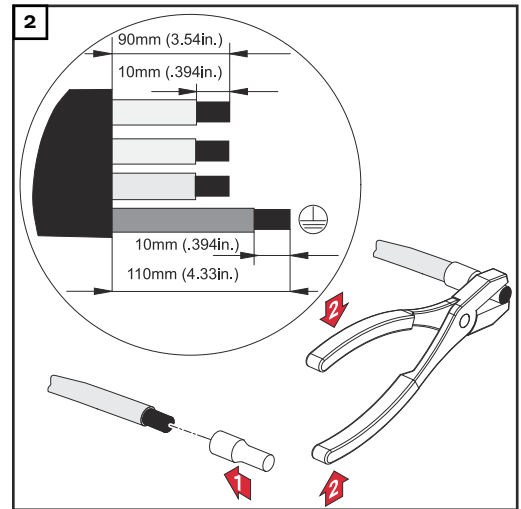
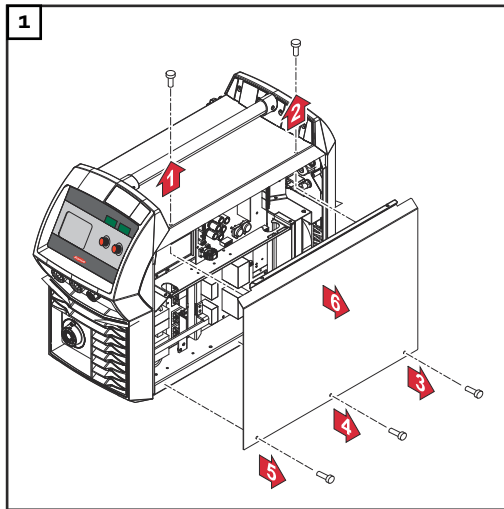

IMPORTANT! Tie the phase conductors near the block terminal using cable ties.

Generator-Powered Operation

Generator-powered operation

The power source is generator-compatible.

The maximum apparent power $S_{1\max}$ of the power source must be known in order to select the correct generator output.

The maximum apparent power $S_{1\max}$ of the power source is calculated for 3-phase devices as follows:

$$S_{1\max} = I_{1\max} \times U_1 \times \sqrt{3}$$

$I_{1\max}$ and U_1 according to the device rating plate and technical data

The generator apparent power S_{GEN} needed is calculated using the following rule of thumb:

$$S_{\text{GEN}} = S_{1\max} \times 1.35$$

A smaller generator can be used when not welding at full power.

IMPORTANT! The generator apparent power S_{GEN} must not be less than the maximum apparent power $S_{1\max}$ of the power source!

NOTE!

The voltage delivered by the generator must never fall outside of the mains voltage tolerance range.

The mains voltage tolerance is specified in the "Technical data" section.

Commissioning

Safety

 **WARNING!**

An electric shock can be fatal.

If the power source is connected to the grid during installation, there is a danger of serious personal injury and property damage.

- ▶ Only carry out work on the device when the power source's power switch is in the - O - position.
 - ▶ Only carry out work on the device when the power source has been disconnected from the grid.
-

 **WARNING!**

Danger of electrical current due to electrically conductive dust in the device.

This can result in severe personal injury and damage to property.

- ▶ Only operate the device if an air filter is fitted. The air filter is a very important safety device for achieving IP 23 protection.
-

General

Commissioning is described with reference to a manual, water-cooled MIG/MAG application.

Information on system components

The steps and activities described below include references to various system components, such as

- Trolley
- Upright bracket
- Cooling units
- Welding torches, etc.

For more detailed information about installing and connecting the system components, please refer to the appropriate Operating Instructions for the system components.

Assembling system components

⚠ WARNING!

Work performed incorrectly can cause serious injury and damage.

- ▶ The following activities must only be carried out by trained and qualified personnel.
- ▶ Please note the information in the "Safety instructions" chapter!

The following diagram shows an overview of how the individual system components are put together.

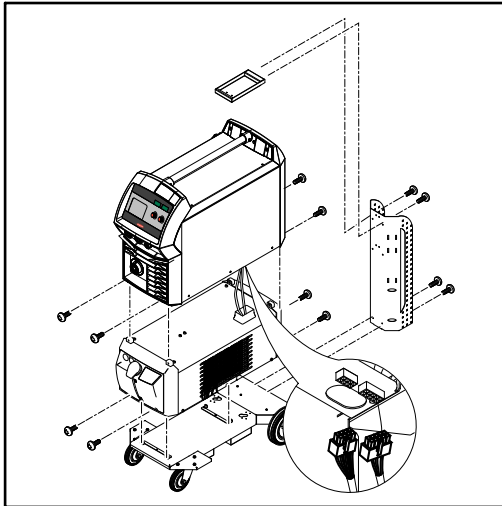

Establishing a ground earth connection

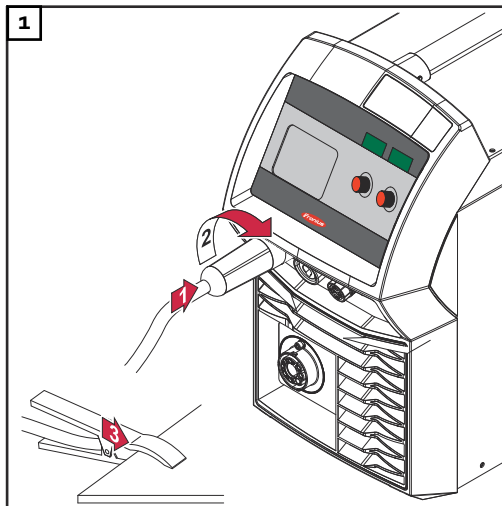

Inserting/changing feed rollers

CAUTION!

Danger due to feed roller holders shooting upwards.

This could result in injury.

- ▶ When unlocking the clamping lever, keep fingers away from the area to the left and right of the clamping lever.

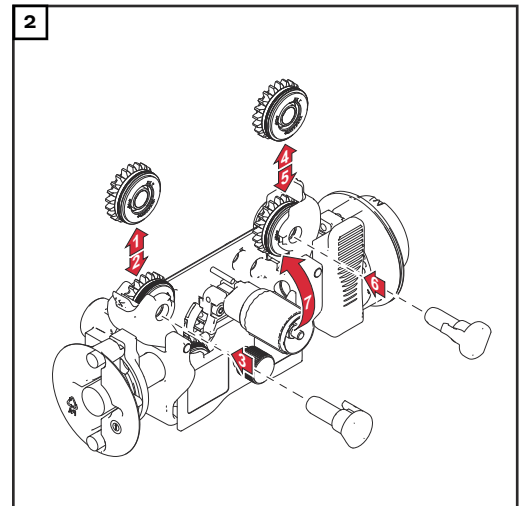
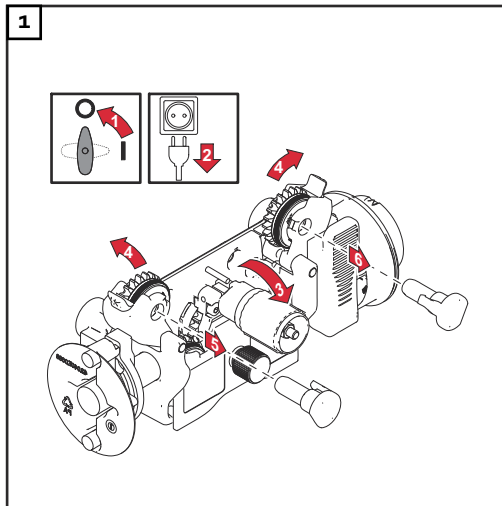

CAUTION!

Danger due to open feed rollers.

This could result in injury.

- ▶ After inserting/changing the feed rollers, always install the protective cover of the 4-roller drive.

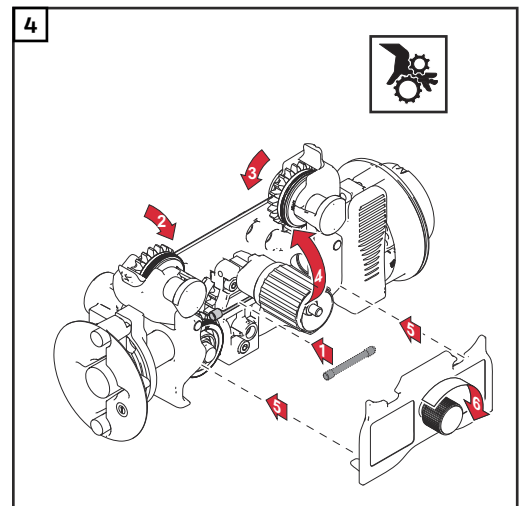
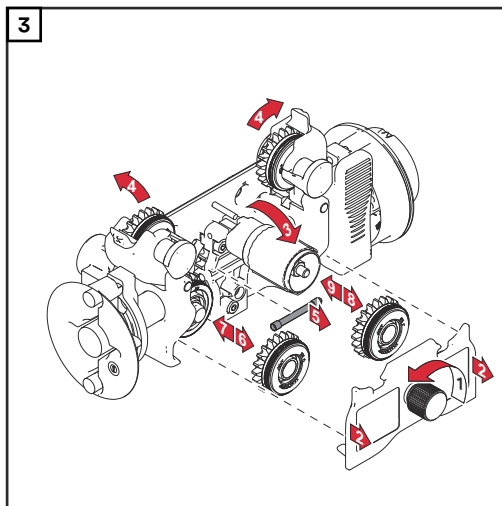

Inserting the wirespool

⚠ CAUTION!

Risk of injury due to springiness of spooled wire electrode.

- ▶ When inserting the wirespool, hold the end of the wire electrode firmly to avoid injuries caused by the wire electrode springing back.

⚠ CAUTION!

Risk of injury from falling wirespool.

- ▶ Ensure that the wirespool is fitted securely to the wirespool holder.

⚠ CAUTION!

Danger of injury and property damage if the wirespool topples over because the locking ring has been placed the wrong way around.

- ▶ Always position the locking ring as shown in the diagram on the left.

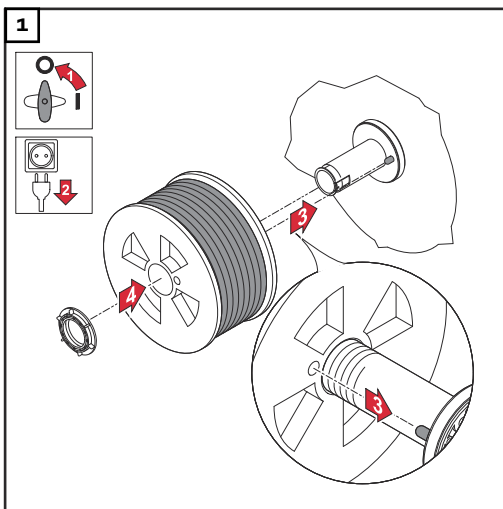
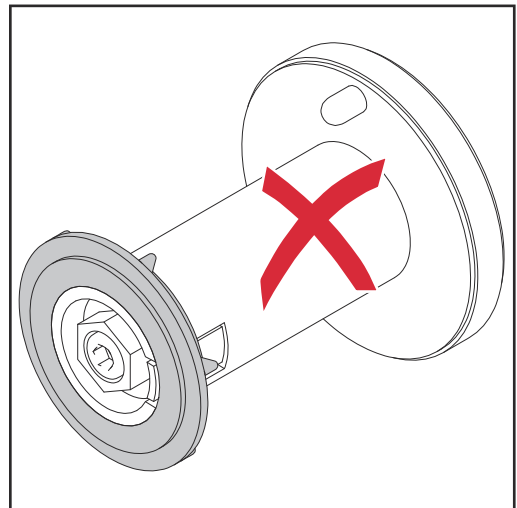
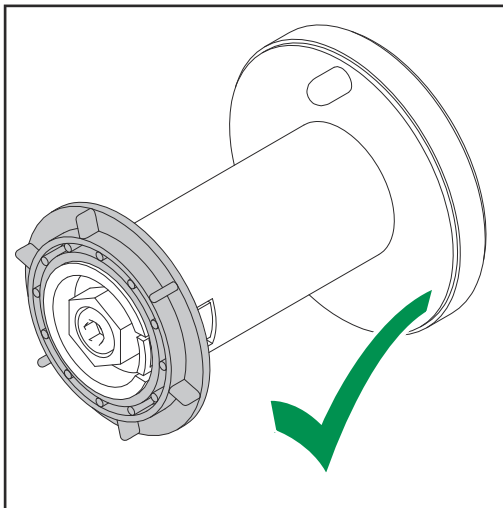

Installing the basket-type spool

CAUTION!

Risk of injury due to springiness of spooled wire electrode.

- ▶ When inserting the basket-type spool, hold the end of the wire electrode firmly to avoid injuries caused by the wire electrode springing back.

CAUTION!

Risk of injury from falling basket-type spool.

- ▶ Make sure that the basket-type spool with basket-type spool adapter is fitted securely to the wirespool holder.

NOTE!

When working with basket-type spools, only use the basket-type spool adapter supplied with the device.

CAUTION!

Danger of injury and property damage if the basket-type spool topples over because the locking ring has been placed the wrong way around.

- ▶ Always position the locking ring as shown in the diagram on the left.

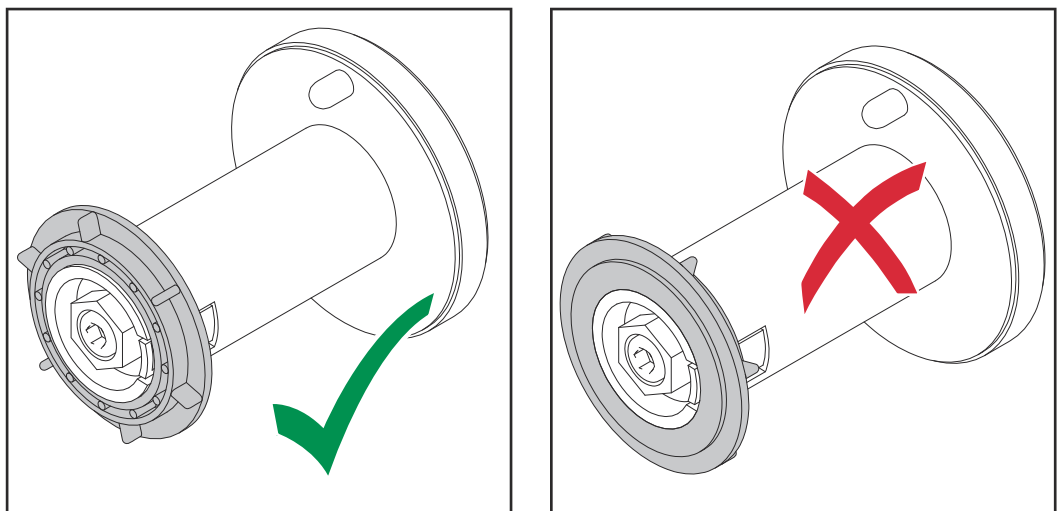

CAUTION!

Danger of injury and damage to property due to falling basket-type spool.

- ▶ Place the basket-type spool on the adapter provided in such a way that the bars on the spool are inside the adapter guideways.

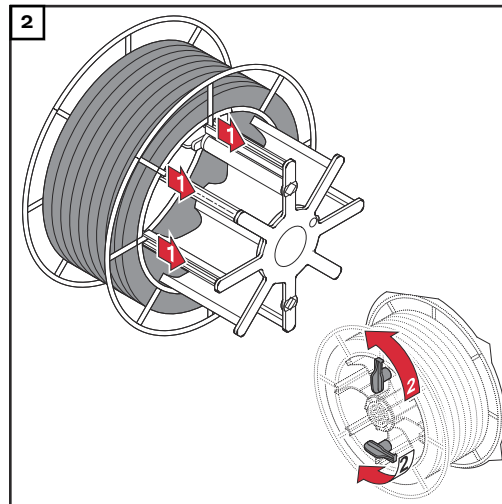
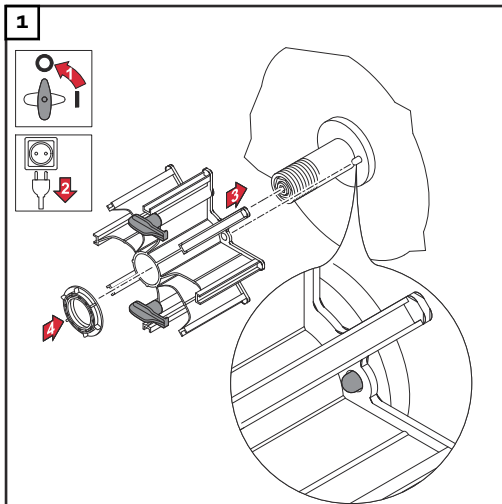

Feed in the wire electrode

⚠ CAUTION!

Risk of injury due to springiness of spooled wire electrode.

- ▶ When inserting the wire electrode into the 4-roller drive, hold the end of the wire electrode firmly to avoid injuries caused by the wire electrode springing back.

⚠ CAUTION!

Risk of damage to the welding torch from sharp end of wire electrode.

- ▶ Deburr the end of the wire electrode well before threading in.

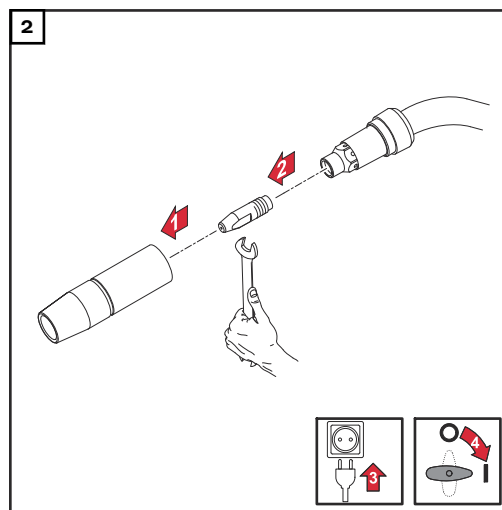
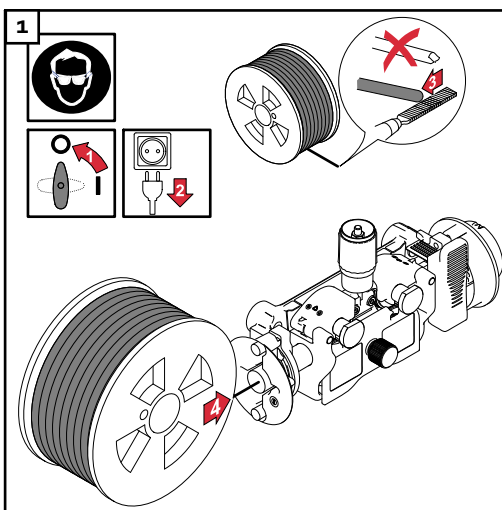

⚠ CAUTION!

Risk of injury from emerging wire electrode.

- ▶ When pressing the "Wire threading" button or the torch trigger, keep the welding torch away from your face and body, and wear suitable protective goggles.

IMPORTANT! To facilitate exact positioning of the wire electrode, the following procedure is possible when the "Wire threading" button is pressed and held down.

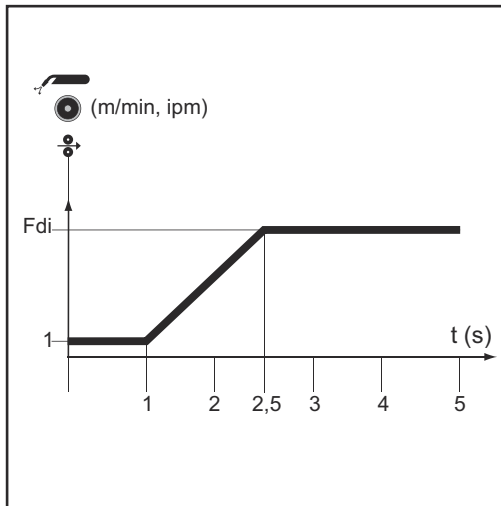

- Hold the button for up to **one second** ... the wire speed stays at 1 m/min or 39.37 ipm for the first second.
- Hold the button for up to **2.5 seconds** ... after one second, the wire speed increases evenly within the next 1.5 seconds.
- Hold the button for **more than 2.5 seconds** ... after 2.5 seconds, the wire is fed at a constant rate equal to the wire speed set for the Fdi welding parameter.

If you release the "Wire threading" button and press it again before one second has elapsed, the sequence starts again from the beginning. This makes it possible to continuously position the wire at a low wire speed of 1 m/min or 39.37 ipm where necessary.

If there is no wire threading button present, the **torch trigger** can be used in a similar way. Before using the torch trigger for wire threading, proceed as follows:

- 1 Press the "Mode" button to select 2-step mode
- 2 Set the "Ito" parameter to "Off" in the Setup menu

⚠ CAUTION!

Danger of injury and damage from electric shock and from the wire electrode emerging from the torch.

When you press the torch trigger:

- ▶ Keep the welding torch away from your face and body
- ▶ Wear suitable protective goggles
- ▶ Do not point the welding torch at people
- ▶ Make sure that the wire electrode does not touch any conductive or grounded parts (e.g., housing, etc.)

IMPORTANT! If the **torch trigger** is pressed instead of the "Wire threading" button, the welding wire runs at the feeder creep speed (depending on the welding program) for the first 3 seconds. After these 3 seconds, wirefeeding is briefly interrupted.

The welding system detects that the welding process should not start, but that the wire is to be threaded in. At the same time, the gas solenoid valve closes, and the welding voltage on the wire electrode is switched off.

If the torch trigger is kept pressed, wirefeeding restarts immediately without shielding gas and welding voltage, and the process continues as described above.

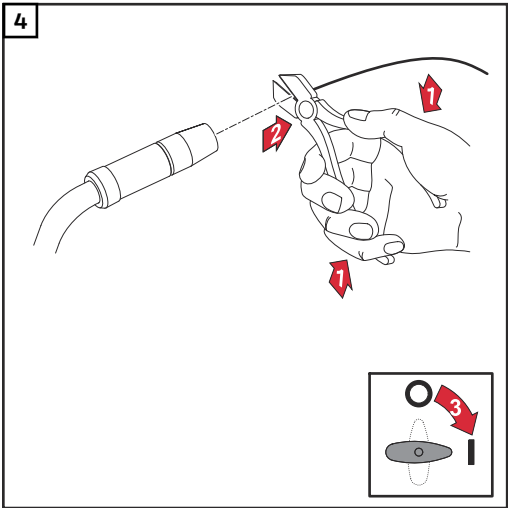
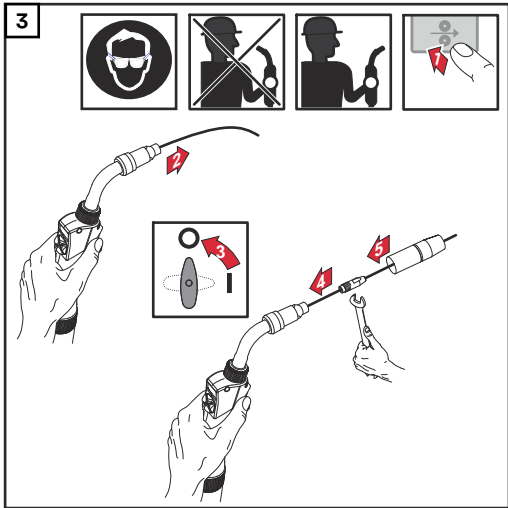

Setting the contact pressure

⚠ CAUTION!

Risk of contact pressure being too high.
 This can result in severe damage to property and poor weld properties.
 ► Set the contact pressure in such a way that the wire electrode is not deformed but nevertheless ensures proper wirefeeding.

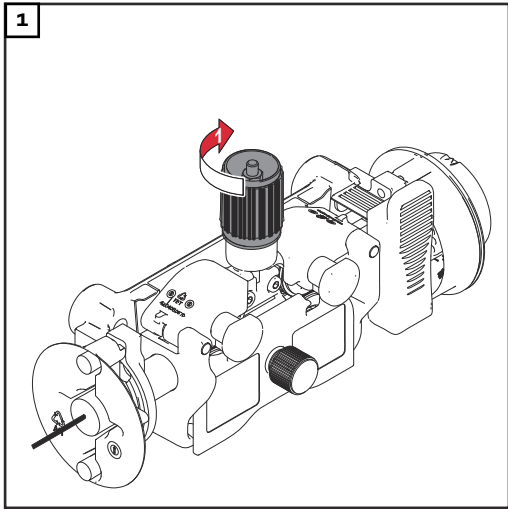

Contact pressure standard values for U-groove rollers:

- Steel: 4 - 5
- CrNi: 4 - 5
- Tubular covered electrodes: 2 - 3

Adjust the brake

NOTE!

After releasing the wire threading button, the wirepool must stop unreeling.

- ▶ If it continues unreeling, readjust the brake.

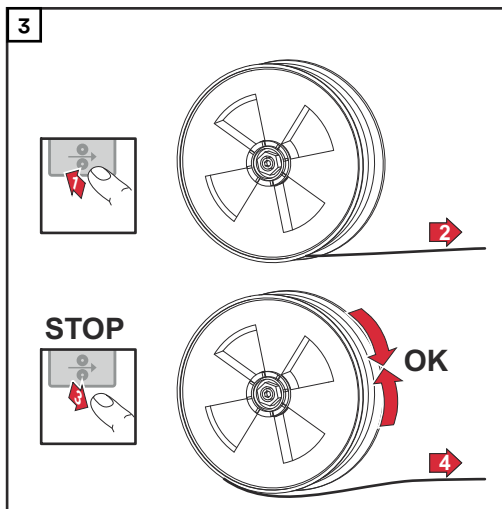
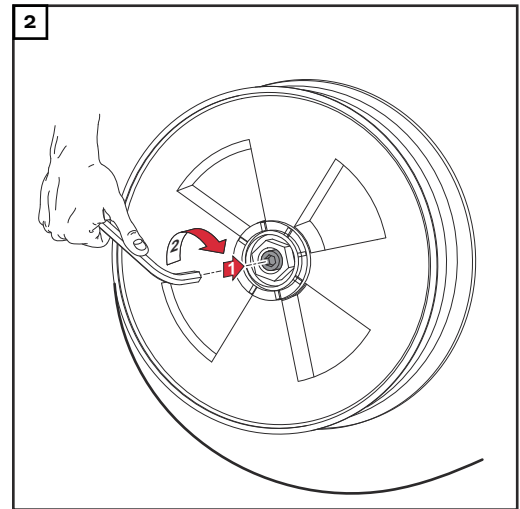
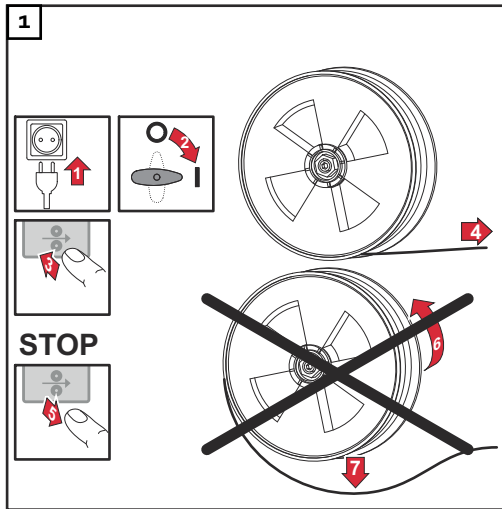

Design of the brake

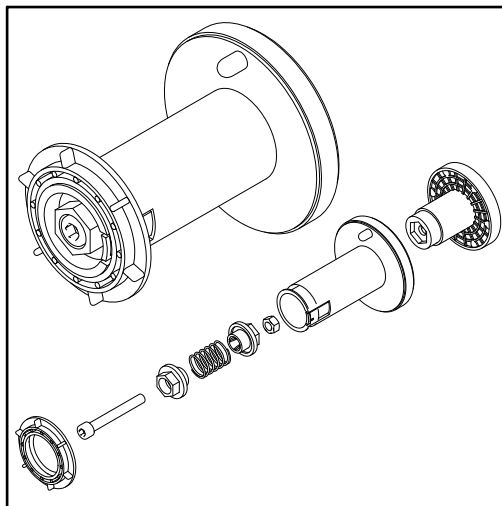

⚠ WARNING!

Danger from incorrect installation.

This can result in severe personal injury and damage to property.

- ▶ Do not dismantle the brake.
- ▶ Maintenance and servicing of brakes is to be carried out by trained, qualified personnel only.

The brake is only available as a complete unit.

The illustration of the brake is for information purposes only.

Setting the date and time when starting for the first time

After switching on the power source for the first time, the date and time must be set. For this purpose, the power source changes to the second level of the service menu; the yEA parameter is selected.

To set the date and time see page [97](#), step 5

MIG/MAG welding

Power Limitation

Safety function "Power limitation" is a safety function for MIG/MAG welding. This means that the power source can be operated at the power limit whilst maintaining process safety.

Wire speed is a determining parameter for welding power. If it is too high, the arc gets smaller and smaller and may be extinguished. In order to prevent this, the welding power is lowered.



If the "MIG/MAG standard synergic welding" or "MIG/MAG pulsed synergic welding" process is selected, the symbol for the "Wire speed" parameter flashes as soon as the safety function trips. The flashing continues until the next welding start-up, or until the next parameter change.

If the "Wire speed" parameter is selected, for example, the reduced value for wire speed is displayed.

MIG/MAG Operating Modes

General



WARNING!

Operating the device incorrectly can cause serious injury and damage to property.

- ▶ Do not use the functions described here until you have fully read and understood the Operating Instructions.
- ▶ Do not use the functions described here until you have fully read and understood all of the Operating Instructions of the system components, especially the safety rules.

For details of the meaning, settings, setting range and units of the available welding parameters (e.g., gas pre-flow time), please refer to the "Setup parameters" chapter.

Symbols and explanations

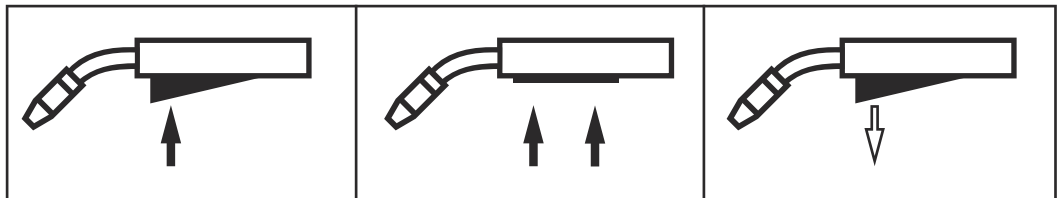

Press the torch trigger | Hold the torch trigger | Release the torch trigger

GPr	Gas pre-flow time
I-S	Starting current Can be increased or decreased depending on the application
SL	Slope Starting current is continuously lowered as far as the welding current and the welding current as far as the final current
I	Welding current phase Even heat input into the parent material whose temperature is raised by the advancing heat
I-E	Final current To fill up end-craters
GPo	Gas post-flow time
SPt	Spot welding time / interval welding time
SPb	Interval pause time

2-step mode

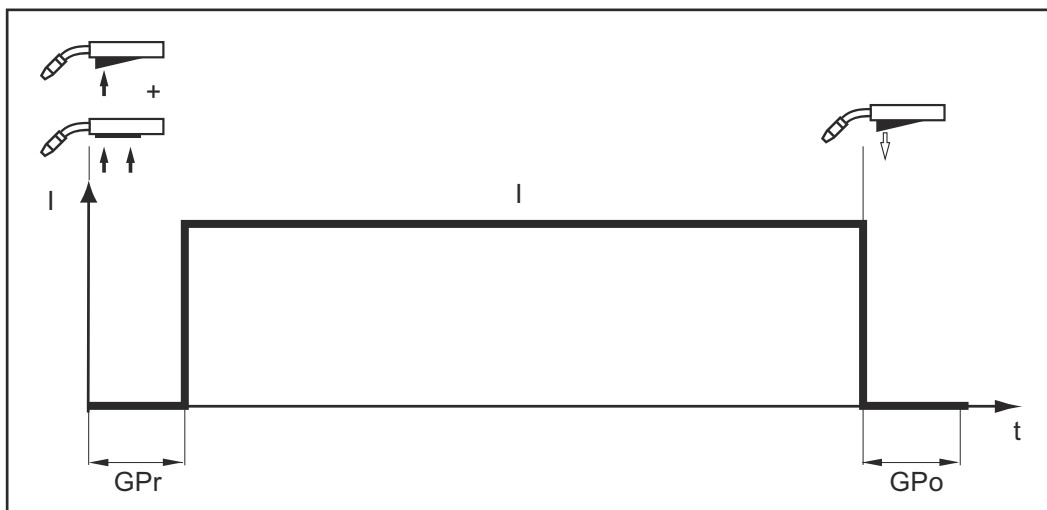

"2-step mode" is suitable for

- Tacking work
- Short weld seams
- Automatic and robot operation

4-step mode

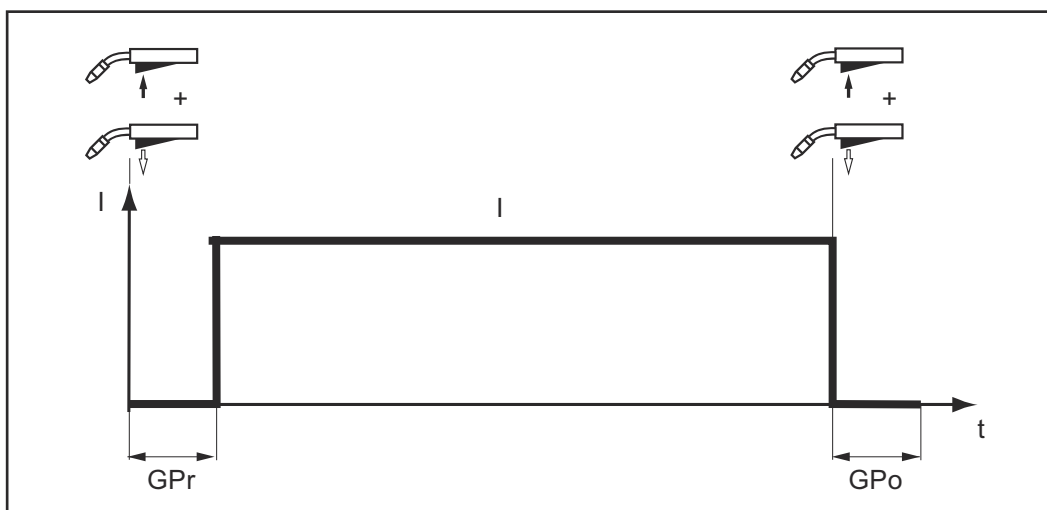

"4-step mode" is suitable for longer weld seams.

Special 2-step mode

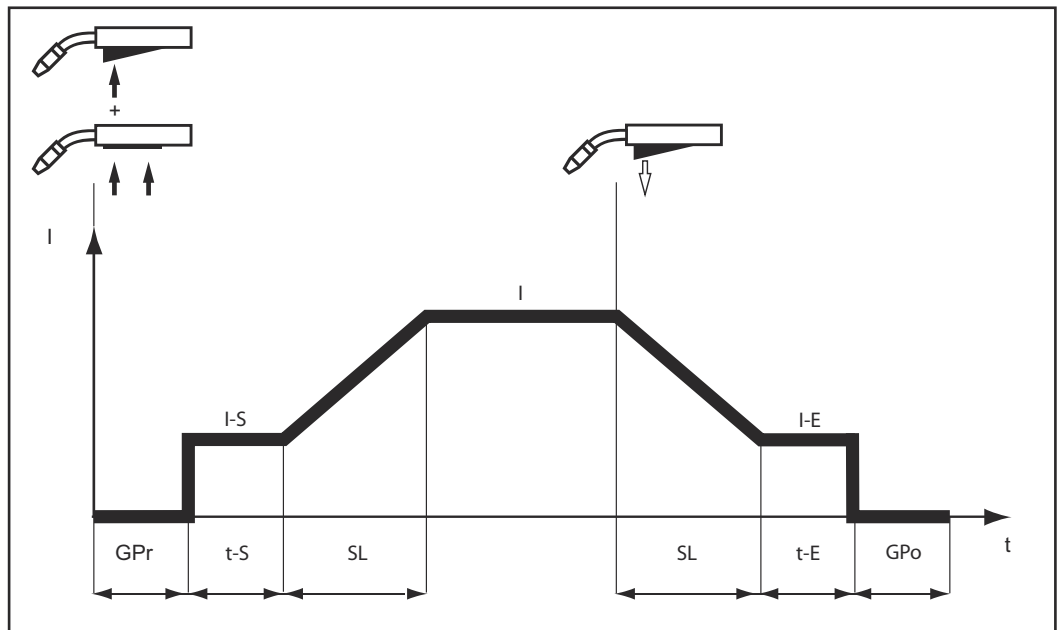

"Special 2-step mode" is ideal for welding in higher power ranges. In special 2-step mode, the arc starts at a lower power, which makes it easier to stabilize.

To activate special 2-step mode:

- 1 Select 2-step mode
- 2 In the Setup menu, set the t-S (starting current duration) and t-E (final current duration) parameters to a value > 0

Special 2-step mode is activated.

- 3 In the Setup menu, set the SL (Slope), I-S (starting current), and I-E (final current) parameters

Special 4-step mode

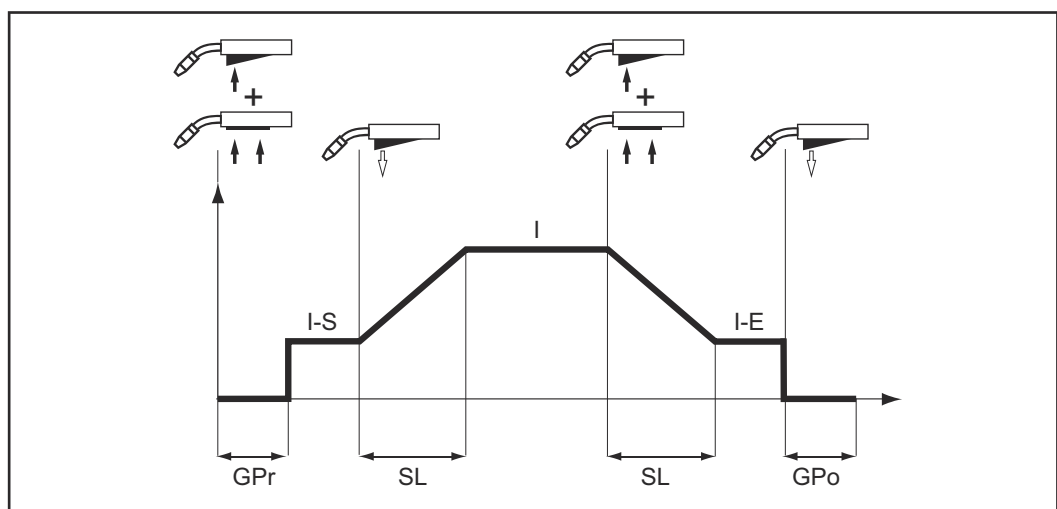

Special 4-step mode allows the starting and final current to be configured in addition to the advantages of 4-step mode.

Spot welding

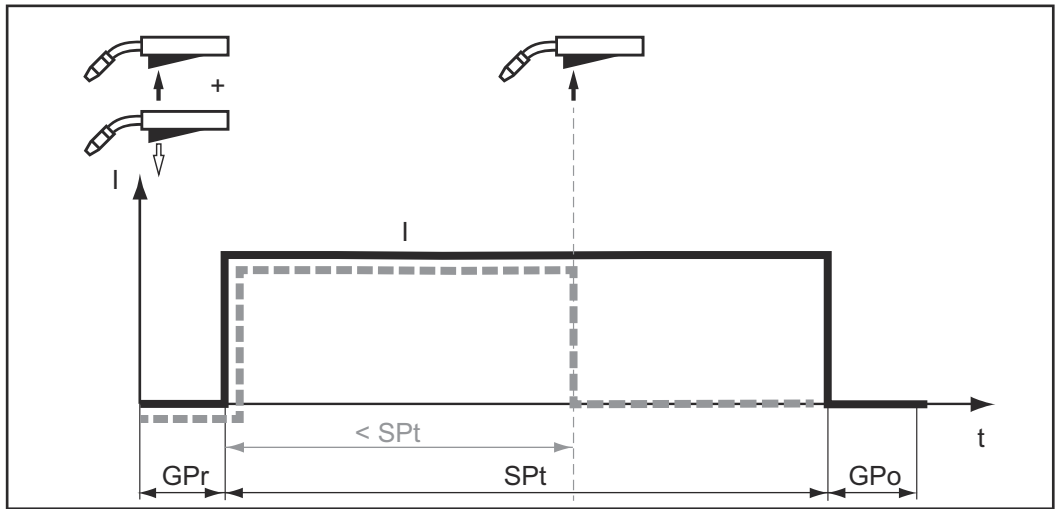

The "Spot welding" mode is suitable for welded joints on overlapped sheets.

Start by pressing and releasing the torch trigger - GPr gas pre-flow time - welding current phase over the SPt spot welding time duration - GPo gas post-flow time.

If the torch trigger is pressed again before the end of the spot welding time (< SPt), the process is canceled immediately.

2-step stitch welding

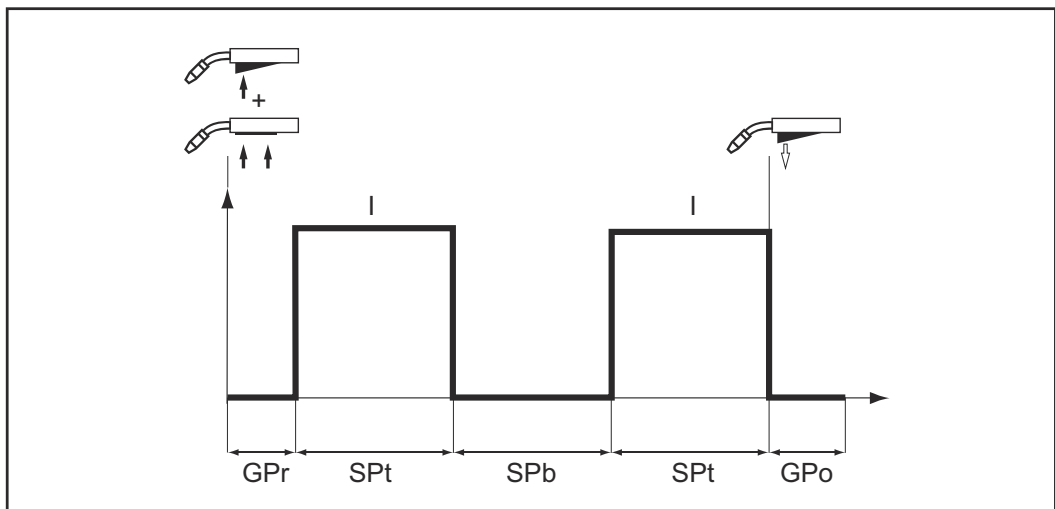

2-step stitch welding

The "2-step stitch welding" mode is suitable for welding short weld seams on thin sheets, to prevent the weld seams from dropping through the parent material.

4-step stitch welding

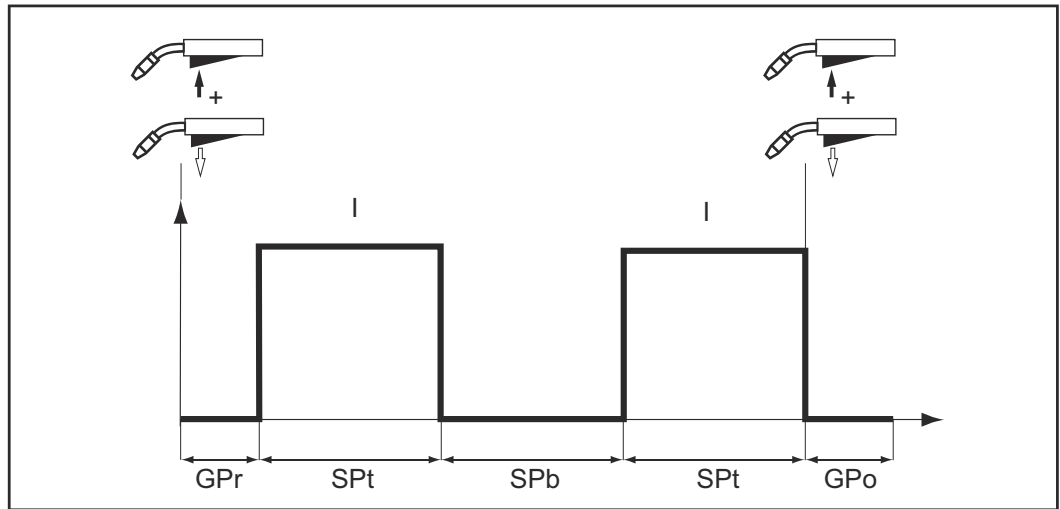

4-step stitch welding

The "4-step stitch welding" mode is suitable for welding longer weld seams on thin sheets, to prevent the weld seams from dropping through the parent material.

MIG/MAG welding

Safety



WARNING!

Danger from incorrect operation and work that is not carried out properly.

This can result in serious personal injury and damage to property.

- ▶ All the work and functions described in this document must only be carried out by technically trained and qualified personnel.
 - ▶ Read and understand this document in full.
 - ▶ Read and understand all safety rules and user documentation for this equipment and all system components.
-



WARNING!

Danger from electrical current.

This can result in serious personal injury and damage to property.

- ▶ Before starting work, switch off all devices and components involved, and disconnect them from the grid.
 - ▶ Secure all devices and components involved so they cannot be switched back on.
 - ▶ After opening the device, use a suitable measuring instrument to check that electrically charged components (such as capacitors) have been discharged.
-

Preparation

- 1** Connect the water hoses of the welding torch to the corresponding connection sockets on the cooling unit
(when using the cooling unit and water-cooled welding torch)
- 2** Insert mains plug
- 3** Set the power switch to - I -:
 - All displays on the control panel briefly illuminate
 - If present: The cooling unit starts to work

IMPORTANT! Observe the safety rules and operating conditions in the Operating Instructions for the cooling unit.

Overview

MIG/MAG welding is composed of the following sections:

- MIG/MAG synergic welding
- MIG/MAG standard manual welding
- Spot welding and stitch welding

MIG/MAG synergic welding

MIG/MAG synergic welding

- 1 Press the "Material" button to select the filler metal to be used.
- 2 Press the "Wire diameter" button to select the diameter of the wire electrode used.
- 3 Press the "Shielding gas" button to select the shielding gas to be used. The assignment of the SP position is in the welding program tables in the appendix.
- 4 Press the "Process" button to select the desired welding process:



MIG/MAG standard synergic welding



MIG/MAG pulsed synergic welding

- 5 Press the "Mode" button to select the desired MIG/MAG mode:



2-step mode



4-step mode



Special 4-step mode

IMPORTANT! Under certain circumstances, it may not be possible to change welding parameters that have been set on the control panel of a system component - such as remote control or wirefeeder - on the control panel of the power source.

- 6 Use the "Parameter selection" buttons to select the welding parameters to be used to specify the welding power:



Sheet thickness



Welding current



Wire speed



Welding voltage

- 7 Use the appropriate selection dial to set the welding parameter.
The value of the parameter is displayed on the digital display located above.

The sheet thickness, welding current, wire speed, and welding voltage parameters are directly linked. It is sufficient to change one of the parameters, as the remaining parameters are immediately adjusted accordingly.

All welding parameter set values remain stored until the next time they are changed. This applies even if the power source is switched off and on again. To display the actual welding current during welding, select the welding current parameter.

- 8 Open the gas cylinder valve
- 9 Adjust quantity of shielding gas:
- Tap the Gas-test button
 - Turn the adjusting screw on the bottom of the gas pressure regulator until the manometer displays the desired quantity of gas
 - Tap the Gas-test button again



CAUTION!

Danger of injury and damage from electric shock and from the wire electrode emerging from the torch.

When you press the torch trigger:

- ▶ Keep the welding torch away from your face and body
- ▶ Wear suitable protective goggles
- ▶ Do not point the welding torch at people
- ▶ Make sure that the wire electrode does not touch any conductive or grounded parts (e.g., housing, etc.)

- 10 Press the torch trigger and start welding

Corrections during welding

The arc length correction and arc-force dynamic parameters can be used to optimize the welding result.



Arc length correction:

- = shorter arc, reduced welding voltage
- 0 = neutral arc
- + = longer arc, increased welding voltage



Pulse / arc-force dynamic correction

For continuous correction of the droplet detachment force in MIG/MAG pulsed synergic welding

- reduced droplet detachment force
- 0 neutral droplet detachment force
- + increased droplet detachment force

For influencing the short-circuiting dynamic at the instant of droplet transfer during MIG/MAG standard synergic welding

- = hard, stable arc
- 0 = neutral arc
- + = soft, low-spatter arc

SynchroPulse welding

SynchroPulse is recommended for welded joints with aluminum alloys whose weld seams should have a rippled appearance. This effect is achieved using a welding power that changes between two operating points.

The two operating points result from a positive and negative change in the welding power to a dFd (delta wire feed) value that can be adjusted in the Setup menu (delta wire feed: 0.0 - 3.0 m/min or 0.0 - 118.1 ipm).

Other parameters for SynchroPulse:

- Frequency F of the operating point change (set in the Setup menu)
- Arc length correction for the lower operating point (set via the arc length correction parameter on the control panel)
- Arc length correction for the higher operating point (set in the Setup menu, parameter Al.2)

To enable SynchroPulse, you must change at least the value of the F (Frequency) parameter from OFF to a variable in the range of 0.5 to 5 Hz in the process Setup menu.

NOTE!

SynchroPulse is not supported with standard manual welding selected.

How SynchroPulse works when used in "Special 4-step" mode

I-S = starting-current phase, SL = Slope, I-E = crater-fill phase, v = wire speed

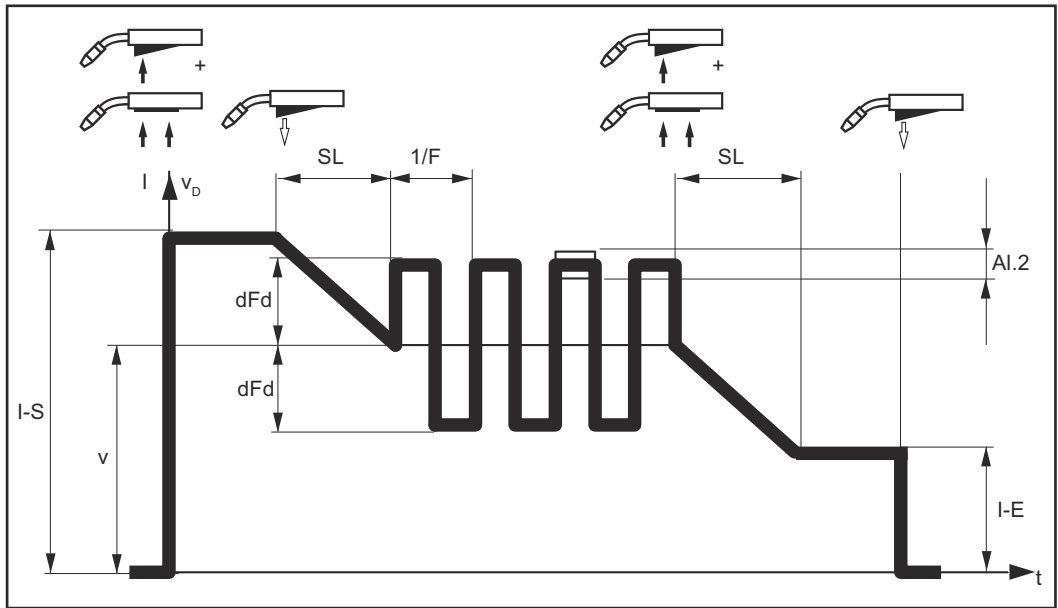

SynchroPulse mode of operation

MIG/MAG Standard Manual Welding

General

The MIG/MAG standard manual welding process is a MIG/MAG welding process with no synergic function. Changing one parameter does not result in any automatic adjustments to the other parameters. All of the variable parameters must therefore be adjusted individually, as dictated by the welding process in question.

Available parameters

The following parameters are available for MIG/MAG manual welding:



Wire speed

1 m/min (39.37 ipm.) - maximum wire speed, e.g., 25 m/min (984.25 ipm.)



Welding voltage TransSteel 4000 Pulse: 15.5 - 31.5 V
TransSteel 5000 Pulse: 14.5 - 39 V



Arc-force dynamic:

For influencing the short-circuiting dynamic at the instant of droplet transfer



Welding current

Only the actual value is displayed

MIG/MAG standard manual welding

1 Press the "Process" button to select the desired welding process:



MIG/MAG standard manual welding

2 Press the "Mode" button to select the desired MIG/MAG mode:



2-step mode



4-step mode

In MIG/MAG standard manual welding, special 4-step mode corresponds to conventional 4-step mode.

IMPORTANT! Under certain circumstances, it may not be possible to change welding parameters that have been set on the control panel of a system component - such as remote control or wirefeeder - on the control panel of the power source.

- 3 Press the "Parameter selection" button to select the wire speed parameter
- 4 Use the selection dial to set the desired wire speed value
- 5 Press the "Parameter selection" button to select the welding voltage parameter
- 6 Use the selection dial to set the desired welding voltage value

The welding parameter values are shown in the digital display located above.

All welding parameter set values remain stored until the next time they are changed. This applies even if the power source is switched off and on again. To display the actual welding current during welding, select the welding current parameter.

To display the actual welding current during welding:

- Press the "Parameter selection" button to select the welding current parameter
- The actual welding current is shown on the digital display during welding.

- 7 Open the gas cylinder valve
- 8 Adjust quantity of shielding gas:
 - Tap the Gas-test button
 - Turn the adjusting screw on the bottom of the gas pressure regulator until the manometer displays the desired quantity of gas
 - Tap the Gas-test button again

 **CAUTION!**

Danger of injury and damage from electric shock and from the wire electrode emerging from the torch.

When you press the torch trigger:

- ▶ Keep the welding torch away from your face and body
- ▶ Wear suitable protective goggles
- ▶ Do not point the welding torch at people
- ▶ Make sure that the wire electrode does not touch any conductive or grounded parts (e.g., housing, etc.)

- 9 Press the torch trigger and start welding

Corrections during welding

To obtain the best possible welding results, the arc-force dynamic parameter will sometimes need to be adjusted.

- 1 Press the "Parameter selection" button to select the arc-force dynamic parameter



- 2 Use the selection dial to set the desired arc-force dynamic value

The welding parameter value is shown in the digital display located above it.

Spot welding and stitch welding

General

The spot welding and stitch welding modes are MIG/MAG welding processes. The spot welding and stitch welding modes are activated on the control panel.

Spot welding is used on welded joints on overlapping sheets that are only accessible on one side.

Stitch welding is used for light-gage sheets. As the wire electrode is not fed continuously, the weld pool can cool down during the intervals. Local overheating leading to the parent material being melted through is largely avoided.

Spot welding

- 1** In the Setup menu, set the spot welding time / stitch welding time SPt

IMPORTANT! Stitch pause time SPb = OFF must be set for spot welding!

- 2** Only for synergic welding:
Use the corresponding buttons to select the filler metal used, the wire diameter, and the shielding gas
- 3** Select the desired welding process:



MIG/MAG standard manual welding



MIG/MAG standard synergic welding



MIG/MAG pulsed synergic welding

- 4** Select spot welding/stitch welding mode:



Spot welding/stitch welding
The spot/stitch/SynchroPulse (SF) indicator lights up on the control panel.

- 5** Depending on the welding process selected, select the desired welding parameters and adjust them using the appropriate selection dial
- 6** Open the gas cylinder valve
- 7** Adjust quantity of shielding gas

⚠ CAUTION!

Danger of injury and damage from electric shock and from the wire electrode emerging from the torch.

When you press the torch trigger:

- ▶ Keep the welding torch away from your face and body
- ▶ Wear suitable protective goggles
- ▶ Do not point the welding torch at people
- ▶ Make sure that the wire electrode does not touch any conductive or grounded parts (e.g., housing, etc.)

8 Spot welding**Procedure for establishing a welding spot:**

- 1** Keep the welding torch vertical
- 2** Press and release the torch trigger
- 3** Maintain the position of the welding torch
- 4** Wait for the gas post-flow time
- 5** Raise the welding torch

Stitch welding

- 1** In the Setup menu, set the stitch pause time SPb

Stitch welding is enabled.

The Int (Interval) parameter is displayed in the Setup menu.

- 2** In the Setup menu for the Int parameter, set the operating mode for stitch welding (2T / 4T)
- 3** In the Setup menu, set the spot welding/stitch welding time SPt
- 4** Only for synergic welding:
Use the corresponding buttons to select the filler metal used, the wire diameter, and the shielding gas
- 5** Select the desired welding process:

 **MANUAL**

MIG/MAG standard manual welding

 **STD SYNERGIC**

MIG/MAG standard synergic welding

 **PULSE SYNERGIC**

MIG/MAG pulsed synergic welding

- 6** Select spot welding/stitch welding mode:



Spot welding/stitch welding

The spot/stitch/SynchroPulse (SF) indicator lights up on the control panel.

- 7 Depending on the welding process selected, select the desired welding parameters and adjust them using the appropriate selection dial
- 8 Open the gas cylinder valve
- 9 Adjust quantity of shielding gas

 **CAUTION!**

Danger of injury and damage from electric shock and from the wire electrode emerging from the torch.

When you press the torch trigger:

- ▶ Keep the welding torch away from your face and body
 - ▶ Wear suitable protective goggles
 - ▶ Do not point the welding torch at people
 - ▶ Make sure that the wire electrode does not touch any conductive or grounded parts (e.g., housing, etc.)
-

- 10 Stitch welding

Procedure for stitch welding:

- 1 Keep the welding torch vertical
- 2 Depending on the stitch mode set under the Int parameter:
Press and hold the torch trigger (2-step mode)
Press and release the torch trigger (4-step mode)
- 3 Maintain the position of the welding torch
- 4 Wait for the welding interval
- 5 Position the welding torch at the next point
- 6 To stop stitch welding, depending on the stitch mode set under the Int parameter:
Release the torch trigger (2-step mode)
Press and release the torch trigger (4-step mode)
- 7 Wait for the gas post-flow time
- 8 Raise the welding torch

EasyJob mode

General

The "Save" buttons allow up to five EasyJob operating points to be saved. Each operating point corresponds to the settings made on the control panel.

EasyJobs can be stored for each welding process.

IMPORTANT! Setup parameters are not saved at this time.

Saving EasyJob operating points

- 1 Press and hold one of the "Save" buttons to save the current settings on the control panel, e.g.
 - The left display reads "Pro"
 - After a short time, the left display switches to the original value



- 2 Release the "Save" button

Retrieving EasyJob operating points

- 1 To retrieve saved settings, press the corresponding "Save" button briefly, e.g.
 - The control panel will show the saved settings



Deleting EasyJob operating points

- 1 Press and hold the relevant "Save" button to delete the memory content of that "Save" button, e.g.
 - The left display reads "Pro".
 - After a short time, the left display switches to the original value



- 2 Keep the "Save" button held down
 - The left display reads "CLr".
 - After a while, both displays show "---"

- 3 Release the "Save" button

Retrieving Easy-Job operating points on the Up/Down welding torch

Press one of the "Save" buttons on the control panel to retrieve the saved settings using the Up/Down welding torch.

- 1 Press one of the "Save" buttons on the control panel, e.g.:



The control panel will show the saved settings.

The "Save" buttons can now be selected using the buttons on the Up/Down welding torch. Vacant "Save" buttons are skipped.

In addition to the "Save" button number lighting up, a number is displayed directly on the Up/Down welding torch:

Display on the Up/Down welding torch	EasyJob operating point on the control panel

TIG welding

Safety



WARNING!

Danger from incorrect operation and work that is not carried out properly.

This can result in serious personal injury and damage to property.

- ▶ All the work and functions described in this document must only be carried out by technically trained and qualified personnel.
- ▶ Read and understand this document in full.
- ▶ Read and understand all safety rules and user documentation for this equipment and all system components.



WARNING!

Danger from electrical current.

This can result in serious personal injury and damage to property.

- ▶ Before starting work, switch off all devices and components involved, and disconnect them from the grid.
- ▶ Secure all devices and components involved so they cannot be switched back on.
- ▶ After opening the device, use a suitable measuring instrument to check that electrically charged components (such as capacitors) have been discharged.

Preparation

- 1 Set the power switch to - O -
- 2 Unplug mains plug
- 3 Removing a MIG/MAG welding torch
- 4 Disconnect the grounding cable from the (-) current socket
- 5 Insert the grounding cable into the (+) current socket and lock
- 6 Connect the other end of the grounding cable to the workpiece
- 7 Insert the bayonet connector of the TIG welding torch into the (-) current socket and twist it clockwise to lock
- 8 Screw the pressure regulator onto the gas cylinder (argon) and tighten it
- 9 Connect the gas hose to the pressure regulator and the TIG gas connection to the power source
- 10 Insert mains plug

TIG welding

CAUTION!

Danger of injury and damage from electric shock.

When the power switch is switched to position - I -, the tungsten electrode of the welding torch is live.

- ▶ Ensure that the tungsten electrode is not touching any people or electrically conductive or grounded parts (housing, etc.).

1 Set the power switch to position - I -: all indicators on the control panel briefly illuminate

2 Press the "Process" button to select the TIG welding process:



The welding voltage is applied to the welding socket with a three second time lag.

IMPORTANT! Under certain circumstances, it may not be possible to change welding parameters that have been set on the control panel of a system component - such as wirefeeder or remote control - on the control panel of the power source.

3 Press the "Parameter selection" button to select the amperage parameter.

4 Use the selection dial to set the desired amperage.
The amperage value is shown on the left-hand digital display.

All the parameter set values set using the selection dial are saved until the next time they are changed. This applies even if the power source is switched off and on again.

5 Set the desired amount of shielding gas on the pressure regulator

6 Commence welding process (ignite arc)

Igniting the arc

When using a welding torch with a torch trigger and TIG Multi Connector plug (with 2-step mode factory setting):

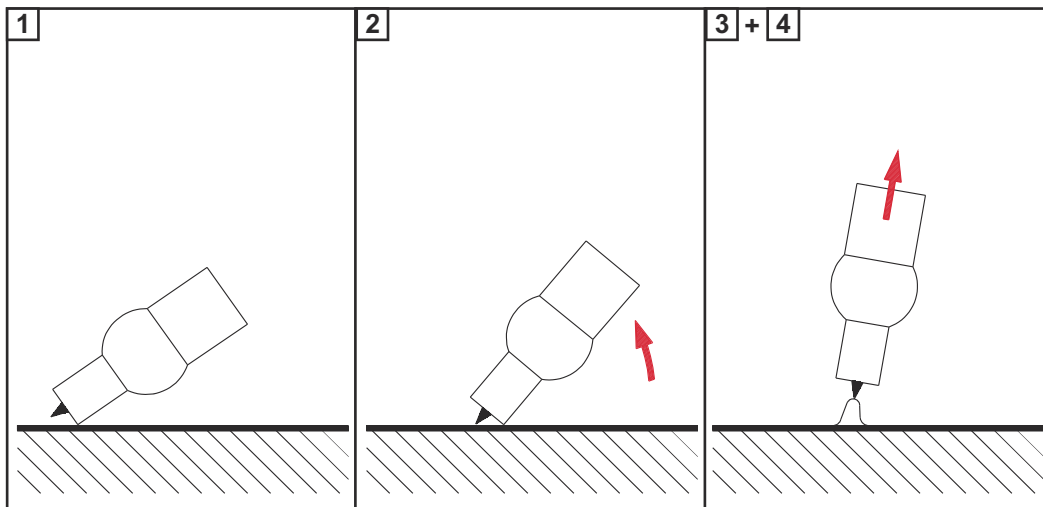

- 1** Position the gas nozzle at the ignition point so that there is a distance of approximately 2 to 3 mm (0.078 to 0.118 in.) between the tungsten electrode and the workpiece
- 2** Gradually tilt the welding torch up until the tungsten electrode touches the workpiece
- 3** Pull back the torch trigger and hold it in this position
Shielding gas flows.
- 4** Raise the welding torch and tilt it into the normal position
The arc now ignites.
- 5** Carry out welding

Ending the welding process

- 1** Raise the TIG welding torch off the workpiece until the arc goes out.
Important! To protect the tungsten electrode, allow the shielding gas to flow after the end of welding until the tungsten electrode has cooled down sufficiently.
- 2** Release the torch trigger

Pulse welding

Applications

Pulsed welding is welding with a pulsing welding current. It is used to weld steel pipes out-of-position or to weld thin sheet metal.

In these applications, the welding current set at the start of welding is not always optimum for the entire welding process:

- If the amperage is too low, the parent material will not be melted enough
- If overheating occurs, there is a danger that the liquid weld pool may drip.

Operating principle

- A low base current I-G rises steeply to the significantly higher pulse current I-P and drops back to the base current I-G after the Duty cycle dcY time.
- This results in an average current that is lower than the set pulse current I-P.
- During pulse welding, small sections of the welding location melt quickly and then rapidly re-solidify.

The power source controls the "Duty cycle dcY" and "Base current I-G" parameters according to the set pulse current (welding current) and pulse frequency.

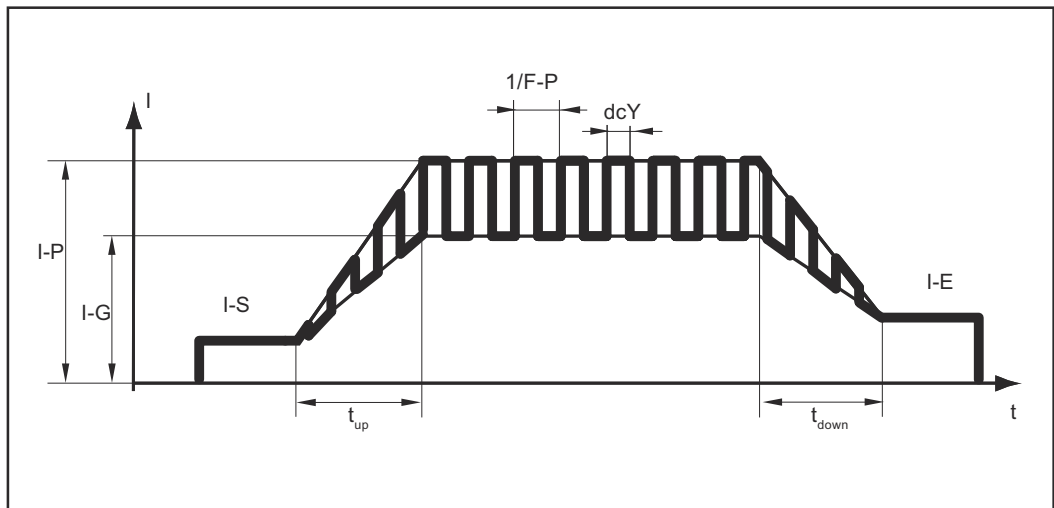

Welding current progression curve

Adjustable parameters:

I-S **Starting current**

I-E **Final current**

F-P **Pulse frequency (1/F-P = Time between two pulses)**

I-P **Pulse current (set welding current)**

Fixed parameters:

t_{up} **UpSlope**

t_{down} **DownSlope**

dcY **Duty cycle**

I-G **Base current**

Activating pulse welding

- 1 Set a value for the F-P setup parameter (pulse frequency)
 - Setting range: 1 - 990 Hz

For a parameter description see section [Parameters for TIG welding](#) from page [105](#).

Manual Metal Arc Welding

Safety

WARNING!

Danger from incorrect operation and work that is not carried out properly.

This can result in serious personal injury and damage to property.

- ▶ All the work and functions described in this document must only be carried out by technically trained and qualified personnel.
- ▶ Read and understand this document in full.
- ▶ Read and understand all safety rules and user documentation for this equipment and all system components.

WARNING!

Danger from electrical current.

This can result in serious personal injury and damage to property.

- ▶ Before starting work, switch off all devices and components involved, and disconnect them from the grid.
- ▶ Secure all devices and components involved so they cannot be switched back on.
- ▶ After opening the device, use a suitable measuring instrument to check that electrically charged components (such as capacitors) have been discharged.

Preparation

- 1 Set the power switch to - O -
- 2 Unplug mains plug

IMPORTANT! Check the rod electrode packaging to determine whether the rod electrodes are for (+) or (-) welding.

- 3 Depending on the type of electrode, insert the grounding cable into the (-) current socket or into the (+) current socket and twist it clockwise to lock
- 4 Connect the other end of the grounding cable to the workpiece
- 5 Depending on the type of electrode, insert the bayonet connector of the electrode holder cable into the free current socket with opposite polarity and twist it clockwise to lock
- 6 Insert mains plug

Manual metal arc welding

CAUTION!

Danger of injury and damage from electric shock.

When the power switch is switched to position - I -, the rod electrode in the electrode holder is live.

- ▶ Ensure that the rod electrode is not touching any people or electrically conductive or grounded parts (housing, etc.).

1 Set the power switch to position - I -: all indicators on the control panel briefly illuminate

2 Press the "Process" button to select the MMA welding process:



The welding voltage is applied to the welding socket with a three second time lag.

If the MMA welding process is selected, a cooling unit, if present, is automatically deactivated. It is not possible to turn it on.

IMPORTANT! Under certain circumstances, it may not be possible to change welding parameters that have been set on the control panel of a system component - such as remote control or wirefeeder - on the control panel of the power source.

3 Press the "Parameter selection" button to select the amperage parameter.

4 Use the selection dial to set the desired amperage.

The amperage value is displayed on the left-hand digital display.

All parameter set values that are set using the selection dial are saved until their next alteration. This applies even if the power source is switched off and on again.

5 Initiate welding process

To display the actual welding current during welding:

- Press the "Parameter selection" button to select the welding current parameter
- The actual welding current is shown on the digital display during welding.

Corrections during welding

To obtain the best possible welding results, the arc-force dynamic parameter will sometimes need to be adjusted.

1 Press the "Parameter selection" button to select the arc-force dynamic parameter

2 Use the selection dial to set the desired arc-force dynamic value

The welding parameter value is shown in the digital display located above it.

To influence the short-circuiting dynamic at the instant of droplet transfer:

- = hard, stable arc
- O = neutral arc
- + = soft, low-spatter arc

HotStart function

To obtain the best possible welding result, the HotStart function will sometimes need to be adjusted.

Advantages

- Improved ignition properties, even when using electrodes with poor ignition properties
- Better fusion of the parent material during the start-up phase, meaning fewer cold-shut defects
- Slag inclusions largely avoided

The setting of the available parameters is described in the section "Setup settings", "Setup menu - level 2".

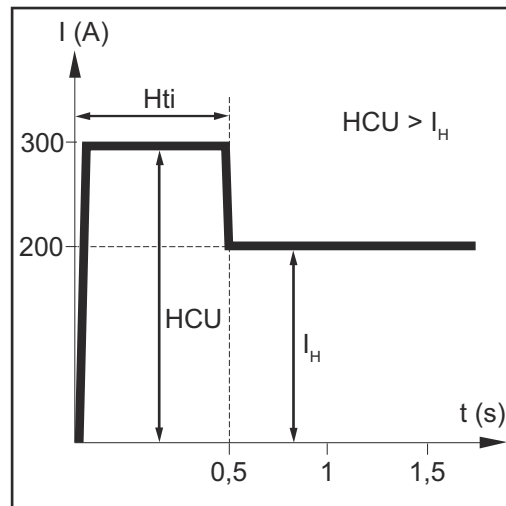
**Key**

H_{ti} Hot-current time,
0 - 2 s,
Factory setting 0.5 s

HCU HotStart current,
100 - 200%,
Factory setting 150%

I_H Main current = set welding current

Function

During the specified hot-current time (H_{ti}), the welding current is increased to a certain value. This value (HCU) is higher than the selected welding current (I_H).

Anti-Stick function

As the arc becomes shorter, the welding voltage may also fall so that the rod electrode is more likely to stick to the workpiece. This may also cause the rod electrode to burn out.

Electrode burn-out is prevented by activating the anti-stick function. If the rod electrode begins to stick, the power source immediately switches the welding current off. The welding process can be resumed without problems once the rod electrode has been detached from the workpiece.

The anti-stick (A_{st}) function can be activated and deactivated in the Setup menu for the setup parameters for MMA welding.

Easy Documentation

General

General

If the Easy Documentation option is available on the power source, the most important welding data for each welding operation can be documented and saved as a CSV file on a USB thumb drive.

A Fronius signature is stored with the welding data, which can be used to check and guarantee the authenticity of the data.

Easy Documentation is activated / deactivated by plugging / unplugging the supplied Fronius USB thumb drive with FAT32 formatting into the back of the power source.

IMPORTANT! To document the welding data, the date and time must be set correctly.

Documented welding data

The following data are documented:

- Device type
- File name
- Part number
- Serial number
- Firmware version of power source
- Firmware of PC board DOCMAG (Easy Documentation)
- Document version
- <https://www.easydocu.weldcube.com> (A PFDF report of selected welding data can be created under this link)

Nr.	Meter Start by plugging in the USB thumb drive; when switching the power source off and on, the meter continues at the last weld seam number. A new CSV file is created after 1000 welding operations.
Date	Date yyyy-mm-dd
Time	Time hh:mm:ss at the start of current flow
Duration	Duration in [s] from start of current flow to end of current (current flow signal)
I	Welding current * in [A]
U	Welding voltage * in [V]
vd	Wire speed * in [m/min]
wfs	Wire speed * in [ipm]
IP	Power * from current values in [W]
IE	Energy from instantaneous values in [kJ] over the entire welding operation
I-Mot	Motor current * in [A]
Synid	Characteristic number for each welding operation
Job	EasyJob number per weld seam

Process	Welding process
Mode	Operating mode
Status	PASS: regular welding IGN: Welding canceled during the ignition phase Err xxx: Welding canceled due to an error; the corresponding service code is documented
Interval	Weld seam number for "Interval" operating mode
Signature	Signature for each weld seam number

* in each case from the main process phase;
in the event of termination in the ignition phase, the average value in the ignition phase is stored and an identifier is output to indicate that the main process phase has been reached

The welding data are documented as average values in the main process phase and for each welding operation.

New CSV file

A new CSV file is generated

- When the USB thumb drive is disconnected and reconnected with the power source switched on
- When the date and time are changed
- From 1000 welding operations
- During a firmware update
- When the USB thumb drive is disconnected and reconnected to another power source (= change of serial number).

PDF report / Fronius signature



By scanning this link...

- A PDF report of the selected welding data can be created
- The authenticity of the welding data can be checked and guaranteed via the Fronius signature read out with the welding data.

<https://easydocu.weldcube.com>

Activating / deactivating Easy Documentation

Activating Easy Documentation

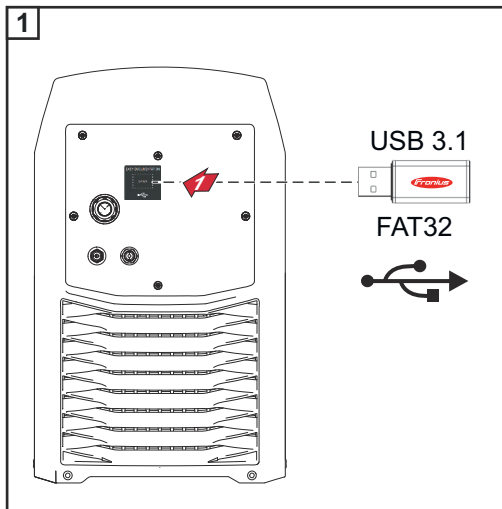

Plug in the USB thumb drive

The power source display shows:

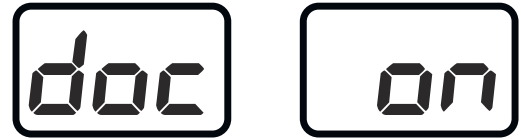

Easy Documentation is activated.

doc | on is also displayed when the power source is switched off and on again with the USB thumb drive connected.

Easy Documentation remains activated.

- Acknowledge the display by pressing the arrow key



- Set the date and time

Set the date and time

Setting the date and time is carried out in the 2nd level of the service menu.

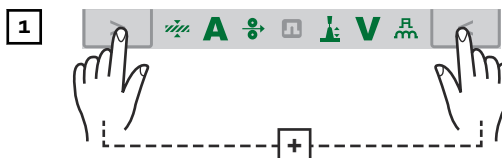

The first parameter in the service menu is displayed.

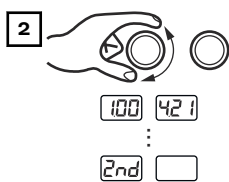

Select the "2nd" setup parameter using the left-hand selection dial

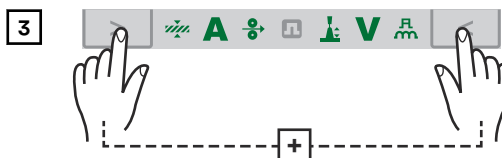

The first parameter in the 2nd level of the service menu is displayed.

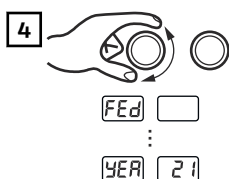

Select the "yEA" (= year) setup parameter using the left-hand selection dial

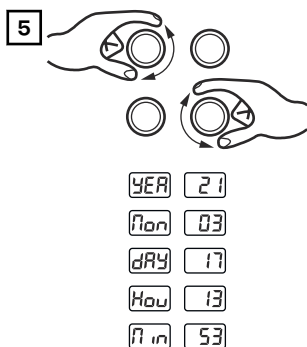

To set the date and time:

- Left-hand selection dial: select parameter
- Right-hand selection dial: change values

Setting ranges:

- yEA Year (20yy; 0 - 99)
- Mon Month (mm; 1 -1 12)
- dAY Day (dd; 1 - 31)
- Hou Hour (hh; 0 - 24)
- Min Minute (mm; 0 - 59)

NOTE!

If the power source is reset to factory settings via setup parameter FAC, the date and time remain stored.

Deactivating Easy Document-ation

⚠ CAUTION!

Risk of data loss or data damage due to premature disconnection of the USB thumb drive

- ▶ Do not disconnect the USB thumb drive until approx. 10 seconds after the end of the last welding operation to ensure correct data transfer.

- 1 Unplug the USB thumb drive from the power source

The power source display shows:



Easy Documentation is deactivated.

- 2 Acknowledge the display by pressing the arrow key



Setup Settings

Setup Menu

General

The Setup menu offers easy access to expert knowledge related to the power source, as well as additional functions. The Setup menu makes it possible to easily adjust the parameters for various tasks.

Operation

Accessing the Setup menu is described with reference to the MIG/MAG standard synergic welding process. Access is the same for the other welding processes.

Accessing the Setup menu

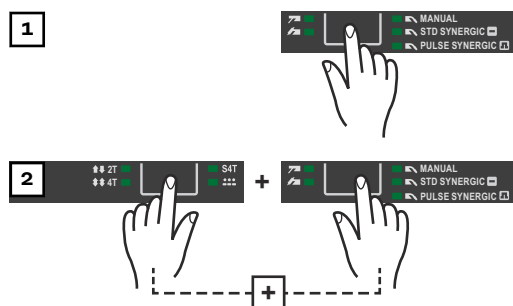

Press the "Process" button to select the "MIG/MAG standard synergic welding" process

The control panel is now located in the Setup menu of the "MIG/MAG standard synergic welding" process - the last selected setup parameter is displayed.

Adjusting parameters

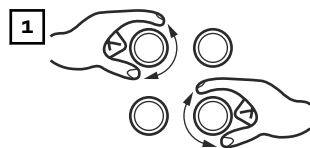

Select the desired setup parameter using the left-hand selection dial

Change the setup parameter value using the right-hand selection dial

Exiting the Setup menu

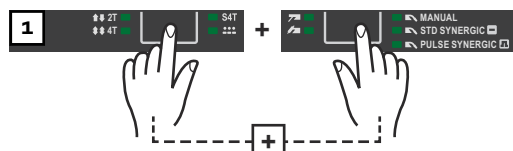

Setup parameters for MIG/MAG synergic welding

The specifications "min." and "max." are used for setting ranges that vary according to the power source, welding program, etc.

GPr **Gas pre-flow time**
Unit: s
Setting range: 0 - 9.9
Factory setting: 0.1

GPo **Gas post-flow time**
Unit: s
Setting range: 0 - 9.9
Factory setting: 0.5

SL **Slope (for special 2-step mode and special 4-step mode)**
Unit: s
Setting range: 0 - 9.9
Factory setting: 0.1

I-S **Starting current (for special 2-step mode and special 4-step mode)**
Unit: % (of welding current)
Setting range: 0 - 200
Factory setting: 100

I-E **Final current (for special 2-step mode and special 4-step mode)**
Unit: % (of welding current)
Setting range: 0 - 200
Factory setting: 50

t-S **Starting current duration (only for special 2-step mode)**
Unit: s
Setting range: 0.0 - 9.9
Factory setting: 0.0

t-E **Final current duration (only for special 2-step mode)**
Unit: s
Setting range: 0.0 - 9.9
Factory setting: 0.0

Fdi **Feeder inching speed**
Unit: m/min (ipm)
Setting range: 1 - max (39.37 - max)
Factory setting: 10 (393.7)

bbc **Burnback effect**
Burnback effect due to wire retraction at the end of welding
When the welding current is switched off, the wire electrode is retracted at 7.5 m/min for the duration of the set bbc value.

Unit: s
Setting range: 0 - 0.2
Factory setting: 0

Ito **Length of wire that is fed before the safety cut-out trips**
Unit: mm (in.)
Setting range: OFF, 5 - 100 (OFF, 0.2 - 3.94)
Factory setting: OFF

NOTE!

The Ito function (length of wire fed until safety cut-out trips) is a safety function.

At high wire speeds in particular, the length of wire fed until the safety cut-out trips can deviate from the set wire length.

SPT **Spot welding time / interval welding time**

Unit: s

Setting range: 0.3 - 5

Factory setting: 1

SPb **Interval pause time**

Unit: s

Setting range: OFF, 0.3 - 10 (in 0.1 s increments)

Factory setting: OFF

IMPORTANT! SPb = OFF must be set for spot welding!

Int **Interval**

Displayed only if a value has been set for SPb

Unit:

Setting range: 2T (2-step), 4T (4-step)

Factory setting: 2T (2-step)

F **Frequency for SynchroPulse**

Unit: Hz

Setting range: OFF, 0.5 - 5

Factory setting: OFF

dFd **Delta wire feed**

Offset welding power for SynchroPulse option

Unit: m/min (ipm)

Setting range: 0 - 3 (0 - 118.1)

Factory setting: 2 (78.7)

AL2 **Arc length correction for upper SynchroPulse operating point**

Unit: % (of welding power)

Setting range: 30 - +30

Factory setting: 0

FAC **Reset power source to factory settings**

Press and hold one of the "Parameter selection" buttons for two seconds to restore the factory settings

- when "PrG" appears on the digital display, the power source has been re-set

IMPORTANT! If the power source is reset, all the personal settings in the Setup menu are lost.

Operating points stored using save buttons remain stored when the power source is reset. The functions in the second level of the setup menu (2nd) are also not deleted. Exception: Ignition time-out function parameter (ito).

2nd **Second level of the Setup menu (see "Setup Menu 2nd Level")**

Setup parameters for MIG/MAG standard manual welding

The specifications "min." and "max." are used for setting ranges that vary according to the power source, welding program, etc.

GPr **Gas pre-flow time**
Unit: s
Setting range: 0 - 9.9
Factory setting: 0.1

GPo **Gas post-flow time**
Unit: s
Setting range: 0 - 9.9
Factory setting: 0.5

Fdi **Feeder inching speed**
Unit: m/min (ipm)
Setting range: 1 - max (39.37 - max)
Factory setting: 10 (393.7)

bbc **Burnback effect**
Burnback effect due to a delayed switch-off of the welding current after the wire electrode has come to a stop. A ball forms on the wire electrode.

Unit: s
Setting range: AUt, 0 - 0.3
Factory setting: AUt

IGC **Ignition current**
Unit: A
Setting range: 100 - 650
Factory setting: 500

Ito **Length of wire that is fed before the safety cut-out trips**
Unit: mm (in.)
Setting range: OFF, 5 - 100 (OFF, 0.2 - 3.94)
Factory setting: OFF

NOTE!

The Ito function (length of wire fed until safety cut-out trips) is a safety function.

At high wire speeds in particular, the length of wire fed until the safety cut-out trips can deviate from the set wire length.

SPT **Spot welding time / interval welding time**
Unit: s
Setting range: 0.3 - 5
Factory setting: 0.3

SPb **Interval pause time**
Unit: s
Setting range: OFF, 0.3 - 10 (in 0.1 s increments)
Factory setting: OFF

Int **Interval**
Displayed only if a value has been set for SPb
Unit:

Setting range: 2T (2-step), 4T (4-step)
 Factory setting: 2T (2-step)

FAC Reset power source to factory settings
 Press and hold one of the "Parameter selection" buttons for two seconds to restore the factory settings
 - when "PrG" appears on the digital display, the power source has been re-set

IMPORTANT! If the power source is reset, all the personal settings in the Setup menu are lost.
 Operating points stored using save buttons remain stored when the power source is reset. The functions in the second level of the setup menu (2nd) are also not deleted. Exception: Ignition time-out function parameter (ito).

2nd **Second level of the Setup menu (see "Setup Menu 2nd Level")**

Setup parameters for MMA welding

IMPORTANT! When resetting the power source using the Factory FAC setup parameter, the hot current time (Hti) and HotStart current (HCU) setup parameters are also reset.

HCU HotStart current
 Unit: %
 Setting range: 100 - 200
 Factory setting: 150

Hti Hot current time
 Unit: s
 Setting range: 0 - 2.0
 Factory setting: 0.5

ASt Anti-stick
 Unit: -
 Setting range: On, OFF
 Factory setting: OFF

FAC Reset power source to factory settings
 Press and hold one of the "Parameter selection" buttons for two seconds to restore the factory settings - when "PrG" appears on the digital display, the power source has been reset.
IMPORTANT! If the power source is reset, all the personal settings are lost.
 Operating points stored using save buttons are not deleted when the power source is reset - they remain stored. The functions in the second level of the setup menu (2nd) are also not deleted. Exception: Ignition time-out function parameter (ito).

2nd **Second level of the Setup menu (see "Setup Menu 2nd Level")**

Parameters for TIG welding

F-P Pulse frequency
 Unit: Hertz

Setting range: OFF; 1 - 990
(up to 10 Hz: in 0.1 Hz increments)
(up to 100 Hz: in 1 Hz increments)
(over 100 Hz: in 10 Hz increments)
Factory setting: OFF

tUP **UpSlope**
Unit: seconds
Setting range: 0.01 - 9.9
Factory setting: 0.5

tdo **DownSlope**
Unit: seconds
Setting range: 0.01 - 9.9
Factory setting: 1

I-S **Starting current**
Unit: % of main current
Setting range: 1 - 200
Factory setting: 35

I-2 **Lowering current**
Unit: % of main current
Setting range: 1 - 100
Factory setting: 50

I-E **Final current**
Unit: % of main current
Setting range: 1 - 100
Factory setting: 30

GPo **Gas post-flow time**
Unit: seconds
Setting range: 0 - 9.9
Factory setting: 9.9

tAC **Tacking**
Unit: seconds
Setting range: OFF, 0.1 - 9.9
Factory setting: OFF

FAC **Reset power source to factory settings**
Press and hold one of the "Parameter selection" buttons for two seconds to restore the factory settings
- when "PrG" appears on the digital display, the power source has been re-set.

When the power source is reset, the majority of the applied settings are deleted. The following values remain:

- Welding circuit resistance and welding circuit inductivity
 - Country-specific setting
-

2nd **Second level of the Setup menu (see "Setup Menu 2nd Level")**

Setup Menu 2nd Level

Limitations

The following restrictions occur in relation to the Setup menu 2nd level:

Setup menu 2nd level cannot be selected:

- during welding
- if the "Gas test" function is active
- if the "Wire threading" function is active
- if the "Wire withdrawal" function is active
- if the "Gas purging" function is active

If level 2 of the Setup menu is selected, the following functions are not available, even in robot mode:

- Welding start-up - the "Power source ready" signal will not be emitted for robot mode
- Gas test
- Wire inching
- Wire withdrawal
- Gas purging

Operation (Setup Menu 2nd Level)

Accessing the 2nd level of the Setup menu:



Press the "Process" button to select the "MIG/MAG standard synergic welding" process

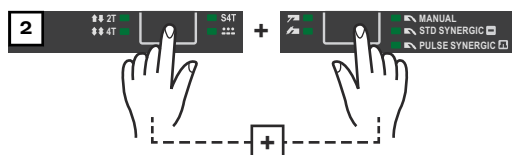

The control panel is now located in the Setup menu of the "MIG/MAG standard synergic welding" process - the last selected setup parameter is displayed.



Select the "2nd" setup parameter using the left-hand selection dial

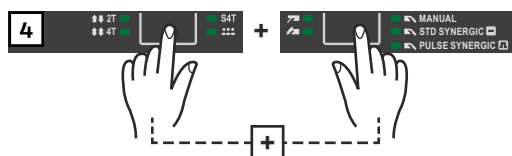

The control panel is now located in the 2nd level of the Setup menu of the "MIG/MAG standard synergic welding" process - the last selected setup parameter is displayed.

Adjusting parameters

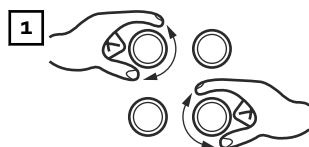

Select the desired setup parameter using the left-hand selection dial

Change the setup parameter value using the right-hand selection dial

Exiting the Setup menu

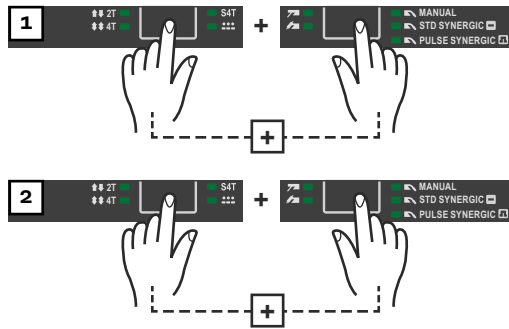

A parameter is displayed in the first level of the Setup menu.

Parameters for MIG/MAG synergic welding in Setup menu 2nd level

SEt **Country-specific setting (Standard/USA) ... Std/US**

Unit: -

Setting range: Std, US (Standard/USA)

Factory setting:

Standard version: Std (measurements: cm/mm)

USA version: US (measures: in.)

Syn **Synergic programs/characteristics**

Standards EN/AWS

Unit: -

Setting range: EUR/US

Factory setting:

Standard version: EUR

USA version: US

C-C **Cooler mode**

(only when the cooling unit is connected)

Unit: -

Setting range: AUt, On, OFF

Factory setting: AUt

AUt:

The cooling unit cuts out after a 2-minute welding off-time.

IMPORTANT! If the coolant temperature and flow monitoring option has been installed in the cooling unit, the cooling unit cuts out as soon as the return-flow temperature drops below 50 °C, but at the earliest after a 2-minute welding off-time.

On:

The cooling unit is always switched on.

OFF:

The cooling unit is always switched off.

IMPORTANT! If the FAC welding parameter is used, the C-C parameter is not reset to the factory setting. If the MMA welding process is selected,

the cooling unit is always switched off, even if the switch is in the "On" position.

C-t **Cooling time**

(only when the cooling unit is connected)

Time from when flow monitoring is triggered until the "no | H₂O" service code is output. For example, if there are air bubbles in the cooling system, the cooling unit will not cut out until the end of this preset time.

Unit: s

Setting range: 5 - 25

Factory setting: 10

IMPORTANT! Every time the power source is switched on, the cooling unit carries out a test run for 180 seconds.

r **Welding circuit resistance (in mOhm)**

See the section "Measuring the welding circuit resistance r" from page [114](#).

L **Welding circuit inductivity (in microhenrys)**

See the section "Displaying the welding circuit inductivity L" from page [116](#).

EnE **Electrical energy of the arc in relation to the welding speed**

Unit: kJ

Setting range: On/OFF

Factory setting: OFF

Since the full range of values (1 kJ - 99999 kJ) cannot be displayed on the three-digit display, the following display format has been selected:

Value in kJ / indicator on display:

1 to 999 / 1 to 999

1000 to 9999 / 1.00 to 9.99 (without unit digit, e.g., 5270 kJ -> 5.27)

10000 to 99999 / 10.0 to 99.9

(without unit or tens digit, e.g., 23580 kJ -> 23.6)

ALC **Correction of the arc length via the welding voltage**

Only for MIG/MAG synergic welding

Setting range: On/OFF

Factory setting: OFF

The arc length depends on the welding voltage. The welding voltage can be individually adjusted in synergic operation.

If the ALC parameter is set to "OFF", individual adjustment of the welding voltage is not possible. The welding voltage adjusts automatically according to the selected welding current or wire speed. When the arc length correction is adjusted, the voltage changes while the welding current and the wire speed remain constant. When adjusting the arc length correction using the selection wheel, the left display is used for the correction value of the arc length. On the right display, the value for the welding voltage

changes at the same time. The left display then shows the original value again, e.g., welding current.

Ejt **EasyJob Trigger**
To activate/deactivate switching between EasyJobs using the torch trigger

Unit: -
Setting range: On/OFF
Factory setting: OFF

Function with MIG/MAG torch trigger

Press torch trigger briefly (< 0.5 s)

No welding taking place:

- Toggles through all MIG/MAG EasyJobs in sequence.
- If an EasyJob is not selected, the torch trigger functions normally.
- If a MIG/MAG EasyJob is not selected, no change is made.

Welding taking place:

- Toggles through MIG/MAG EasyJobs with the same operating mode (4-step, special 4-step, 4-step stitch welding) and with the same welding process.
- It is not possible to switch during spot welding.

Function with MIG/MAG Up/Down key

If an EasyJob is selected, the EasyJob is changed, otherwise the welding current is changed.

No welding taking place:

- Toggles through all MIG/MAG EasyJobs in sequence.

Welding taking place:

- Toggles through MIG/MAG EasyJobs with the same operating mode (2-step, 4-step, special 4-step, 4-step stitch welding) and with the same welding process.
Switching back is possible.

**Parameters for
MIG/MAG
standard manual
welding in Setup
menu 2nd level**

SEt **Country-specific setting (Standard/USA) ... Std/US**

Unit: -
Setting range: Std, US (Standard/USA)
Factory setting:
Standard version: Std (measurements: cm/mm)
USA version: US (measures: in.)

C-C **Cooler mode**
(only when the cooling unit is connected)

Unit: -
Setting range: AUt, On, OFF
Factory setting: AUt

AU:

The cooling unit cuts out after a 2-minute welding off-time.

IMPORTANT! If the coolant temperature and flow monitoring option has been installed in the cooling unit, the cooling unit cuts out as soon as the return-flow temperature drops below 50 °C, but at the earliest after a 2-minute welding off-time.

On:

The cooling unit is always switched on.

OFF:

The cooling unit is always switched off.

IMPORTANT! If the FAC welding parameter is used, the C-C parameter is not reset to the factory setting. If the MMA welding process is selected, the cooling unit is always switched off, even if the switch is in the "On" position.

C-t **Cooling time**

(only when the cooling unit is connected)

Time from when flow monitoring is triggered until the "no | H2O" service code is output. For example, if there are air bubbles in the cooling system, the cooling unit will not cut out until the end of this preset time.

Unit: s

Setting range: 5 - 25

Factory setting: 10

IMPORTANT! Every time the power source is switched on, the cooling unit carries out a test run for 180 seconds.

r **Welding circuit resistance (in mOhm)**

See the section "Measuring the welding circuit resistance r" from page [114](#).

L **Welding circuit inductivity (in microhenrys)**

See the section "Displaying the welding circuit inductivity L" from page [116](#).

EnE **Electrical energy of the arc in relation to the welding speed**

Unit: kJ

Setting range: On/OFF

Factory setting: OFF

Since the full range of values (1 kJ - 99999 kJ) cannot be displayed on the three-digit display, the following display format has been selected:

Value in kJ / indicator on display:

1 to 999 / 1 to 999

1000 to 9999 / 1.00 to 9.99 (without unit digit, e.g., 5270 kJ -> 5.27)

10000 to 99999 / 10.0 to 99.9
(without unit or tens digit, e.g., 23580 kJ -> 23.6)

Ejt **EasyJob Trigger**

To activate/deactivate switching between EasyJobs using the torch trigger

Unit: -

Setting range: On/OFF

Factory setting: OFF

Function with MIG/MAG torch trigger

Press torch trigger briefly (< 0.5 s)

No welding taking place:

- Toggles through all MIG/MAG EasyJobs in sequence.
- If an EasyJob is not selected, the torch trigger functions normally.
- If a MIG/MAG EasyJob is not selected, no change is made.

Welding taking place:

- Toggles through MIG/MAG EasyJobs with the same operating mode (4-step, special 4-step, 4-step stitch welding) and with the same welding process.
- It is not possible to switch during spot welding.

Function with MIG/MAG Up/Down key

If an EasyJob is selected, the EasyJob is changed, otherwise the welding current is changed.

No welding taking place:

- Toggles through all MIG/MAG EasyJobs in sequence.

Welding taking place:

- Toggles through MIG/MAG EasyJobs with the same operating mode (2-step, 4-step, special 4-step, 4-step stitch welding) and with the same welding process.
Switching back is possible.
-

Parameters for manual metal arc welding in Setup menu 2nd level

SEt **Country-specific setting (Standard/USA) ... Hour/US**

Unit:

Setting range: Std, US (Standard/USA)

Factory setting:

Standard version: Std (dimensions: cm / mm)

USA version: US (dimensions: in.)

r **r (resistance) - welding circuit resistance (in mOhm)**

See the section "Measuring the welding circuit resistance r" from page [114](#).

L **L (inductivity) - welding circuit inductivity (in microhenrys)**

See the section "Displaying the welding circuit inductivity L" from page [116](#).

**Parameters for
TIG welding
(Setup menu 2nd
level)**

SEt	<p>Country-specific setting (Standard/USA) ... Hour/US</p> <p>Unit:</p> <p>Setting range: Std, US (Standard/USA)</p> <p>Factory setting:</p> <p>Standard version: Std (dimensions: cm / mm)</p> <p>USA version: US (dimensions: in.)</p>
-----	---

C-C	<p>Cooling unit control</p> <p>(only with TransSteel 3500c MP and if cooling unit is connected)</p> <p>Unit:</p> <p>Setting range: Aut, On, OFF</p> <p>Factory setting: Aut</p> <p>Aut: the cooling unit cuts out after a 2-minute welding off-time.</p> <p>IMPORTANT! If the coolant temperature and flow monitoring options have been installed in the cooling unit, the cooling unit cuts out as soon as the return-flow temperature drops below 50 °C, but at the earliest after a 2-minute welding off-time.</p> <p>On: The cooling unit is always switched on</p> <p>OFF: The cooling unit is always switched off</p> <p>IMPORTANT! If the FAC welding parameter is used, the C-C parameter is not reset to the factory setting. If the MMA welding process is selected, the cooling unit is always switched off, even if the switch is in the "On" position.</p>
-----	--

C-t	<p>Cooling time</p> <p>(only with TransSteel 3500c MP and if cooling unit is connected)</p> <p>Time from when flow monitoring is triggered until the "no H2O" service code is output. For example, if there are air bubbles in the cooling system, the cooling unit will not cut out until the end of this preset time.</p> <p>Unit: s</p> <p>Setting range: 5 - 25</p> <p>Factory setting: 10</p> <p>IMPORTANT! Every time the power source is switched on, the cooling unit carries out a test run for 180 seconds.</p>
-----	---

Measuring the Welding Circuit Resistance r

General

Measuring the welding circuit resistance makes it possible to have a constant welding result at all times, even with hosepacks of different lengths. The welding voltage at the arc is then always precisely regulated, regardless of the length and cross-sectional area of the hosepack. The use of arc length correction is no longer required.

The calculated welding circuit resistance is shown on the display.

r = welding circuit resistance in milliohm (mOhm)

If the welding circuit resistance has been measured correctly, the set welding voltage will correspond exactly to the welding voltage at the arc. If you manually measure the voltage on the output jacks of the power source, this voltage will be higher than the welding voltage at the arc - that is, higher by the same amount as the voltage drop of the hosepack.

The welding circuit resistance depends on the hosepack used:

- If the length or cross-sectional area of the hosepack has changed, measure the welding circuit resistance again
- Measure the welding circuit resistance for every welding process separately with the appropriate welding power-leads

Measuring the welding circuit resistance (MIG/MAG welding)

NOTE!

Incorrect measurement of the welding circuit resistance can have a negative effect on the welding result.

- ▶ Ensure that the workpiece has an optimum contact surface in the area of the earthing clamp (clean surface, no rust, etc.).

- 1 Make sure that one of the MANUAL / STD SYNERGIC / pulsed synergic welding processes is selected
- 2 Establish a ground earth connection to the workpiece
- 3 Access the Setup menu 2nd level (2nd)
- 4 Select parameter "r"
- 5 Remove the gas nozzle from the welding torch
- 6 Screw on the contact tip
- 7 Ensure that the wire electrode does not protrude from the contact tip

NOTE!

Incorrect measurement of the welding circuit resistance can have a negative effect on the welding result.

- ▶ Ensure that the workpiece has an optimum contact surface for the contact tip (clean surface, no rust, etc.).

- 8 Place the contact tip flush against the workpiece surface
- 9 Press the torch trigger briefly
 - The welding circuit resistance is calculated. "run" is shown on the display during the measurement

The measurement is finished when the welding circuit resistance is shown on the display in mOhm (for example 11.4).

- 10 Fit the gas nozzle back onto the welding torch

Measuring the welding circuit resistance (MMA welding)

NOTE!

Incorrect measurement of the welding circuit resistance can have a negative effect on the welding result.

- ▶ Ensure that the workpiece has an optimum contact surface in the area of the earthing clamp (clean surface, no rust, etc.).

- 1 Ensure that the Stabelektroden-Schweißen welding process is selected
- 2 Establish a ground earth connection to the workpiece
- 3 Access the Setup menu 2nd level (2nd)
- 4 Select parameter "r"

NOTE!

Incorrect measurement of the welding circuit resistance can have a negative effect on the welding result.

- ▶ Ensure that the workpiece has an optimum contact surface for the electrode (clean surface, no rust, etc.).

- 5 Place the electrode flush against the workpiece surface
- 6 Press the "Parameter selection" button (right)



The welding circuit resistance is calculated. During the measurement the display shows "run".

The measurement is finished when the welding circuit resistance is shown on the display in mOhm (for example 11.4).

Displaying the welding circuit Inductivity L

General

The way that the hosepack is arranged has a very significant effect on the welding circuit inductivity and therefore affects the welding process. It is important to lay the hosepacks correctly in order to obtain the best possible welding result.

Displaying the welding circuit inductivity

The setup parameter "L" is used to display the most recently calculated welding circuit inductivity. The welding circuit inductivity is adjusted when the welding circuit resistance is measured. Detailed information in this regard can be found under the "Welding circuit resistance" chapter.

- 1 Access the Setup menu 2nd level (2nd)
- 2 Select parameter "L"

The most recently calculated welding circuit inductivity L is shown on the right-hand digital display.

L ... Welding circuit inductivity (in microhenrys)

Laying the hosepacks correctly



Troubleshooting and Maintenance

Troubleshooting

General

The devices are equipped with an intelligent safety system, which largely negates the need for melting-type fuses. Melting-type fuses therefore no longer need to be replaced. After a possible malfunction has been remedied, the device is ready for use again.

Safety

WARNING!

Danger from incorrect operation and work that is not carried out properly.

This can result in serious personal injury and damage to property.

- ▶ All the work and functions described in this document must only be carried out by technically trained and qualified personnel.
- ▶ Read and understand this document in full.
- ▶ Read and understand all safety rules and user documentation for this equipment and all system components.

WARNING!

Danger from electrical current.

This can result in serious personal injury and damage to property.

- ▶ Before starting work, switch off all devices and components involved, and disconnect them from the grid.
- ▶ Secure all devices and components involved so they cannot be switched back on.
- ▶ After opening the device, use a suitable measuring instrument to check that electrically charged components (such as capacitors) have been discharged.

WARNING!

Danger due to insufficient ground conductor connection.

This can result in serious personal injury and damage to property.

- ▶ The housing screws provide a suitable ground conductor connection for grounding the housing.
- ▶ The housing screws must not under any circumstances be replaced by other screws without a reliable ground conductor connection.

Displayed Service Codes

If an error message that is not described here appears on the displays, first try to resolve the problem as follows:

- 1 Switch the power source power switch to the -O- position
- 2 Wait 10 seconds
- 3 Switch the power switch to the -I- position

If the error occurs again despite several attempts to eliminate it, or if the troubleshooting measures listed here are unsuccessful.

- 1 Make a note of the error message displayed
- 2 Note down the configuration of the power source

3 Contact our After-Sales Service team with a detailed description of the error

ESr | 20

Cause: The cooling unit used is not compatible with the power source

Remedy: Connect compatible cooling unit

ELn | 8

Cause: The connected wirefeeder is not supported

Remedy: Connect supported wirefeeder

ELn | 12

Cause: Different control panels for selecting materials are in the system

Remedy: Connect similar control panels to select materials

ELn | 13

Cause: Impermissible change of welding process during welding

Remedy: During welding do not make any impermissible change to the welding process, reset error message by pressing any button

ELn | 14

Cause: More than one robot interface is connected

Remedy: Only one robot interface may be connected, check the system configuration

ELn | 15

Cause: More than one remote control is connected

Remedy: Only one remote control may be connected, check the system configuration

Err | IP

Cause: The power source control has detected a primary overvoltage

Remedy: Check the grid voltage.

If the service code persists, switch off the power source, wait for 10 seconds and then switch the power source on again.

If the error still persists, contact the After-Sales Service team

Err | PE

Cause: The earth current watchdog has triggered the safety cut-out of the power source.

Remedy: Switch off the power source

Place the power source on an insulating surface

Connect the grounding cable to a section of the workpiece that is closer to the arc

Wait for 10 seconds and then switch the power source on again

If you have tried this several times and the error keeps recurring, contact the After-Sales Service team

PHA | SE1

Cause: The power source is being used in single-phase mode

Remedy: -

PHA | SE3

Cause: The power source is being used in three-phase mode

Remedy: -

Err | 51

Cause: Mains undervoltage: the grid voltage has fallen below the tolerance range

Remedy: Check the grid voltage. If the service code persists, contact the After-Sales Service team

Err | 52

Cause: Mains overvoltage: the grid voltage has risen above the tolerance range

Remedy: Check the grid voltage. If the service code persists, contact the After-Sales Service team

EFd 5

Cause: Incorrect wirefeeder connected

Remedy: Connect correct wirefeeder

EFd 8

Cause: Wirefeeder overtemperature

Remedy: Allow wirefeeder to cool down

EFd | 81, EFd | 83

Cause: Fault in the wirefeed system (overcurrent in wirefeeder drive)

Remedy: Arrange the hosepack in as straight a line as possible; check that there are no kinks or dirt in the inner liner; check the contact pressure on the 4 roller drive

Cause: Wirefeeder motor is sticking or faulty

Remedy: Check the wirefeeder motor or contact the After-Sales Service team

to0 | xxx

Note: xxx stands for a temperature value

Cause: Overtemperature in the primary circuit of the power source

Remedy: Allow power source to cool down, check air filter and clean if necessary, check that fan is on

to1 | xxx

Note: xxx stands for a temperature value

Cause: Overtemperature on the booster located in the power source

Remedy: Allow power source to cool down, check air filter and clean if necessary, check that fan is on

to2 | xxx

Note: xxx stands for a temperature value

Cause: Overtemperature in the secondary circuit of the power source

Remedy: Allow power source to cool down, check that fan is on

to3 | xxx

Note: xxx stands for a temperature value

Cause: Overtemperature in wirefeeder motor

Remedy: Allow wirefeeder to cool down

to4 | xxx

Note: xxx stands for a temperature value

Cause: Overtemperature in welding torch

Remedy: Allow welding torch to cool down

to5 | xxx

Note: xxx stands for a temperature value

Cause: Overtemperature in cooling unit

Remedy: Allow cooling unit to cool down, check that fan is on

to6 | xxx

Note: xxx stands for a temperature value

Cause: Overtemperature on the power source transformer

Remedy: Allow power source to cool down, check air filter and clean if necessary, check that fan is on

to7 | xxx

Note: xxx stands for a temperature value

Cause: Overtemperature in the power source

Remedy: Allow power source to cool down, check air filter and clean if necessary, check that fan is on

tu0 | xxx

Note: xxx stands for a temperature value

Cause: Undertemperature in the power source primary circuit

Remedy: Place power source in a heated room and allow it to warm up

tu1 | xxx

Note: xxx stands for a temperature value

Cause: Undertemperature on the booster located in the power source

Remedy: Place power source in a heated room and allow it to warm up

tu2 | xxx

Note: xxx stands for a temperature value

Cause: Undertemperature in the power source secondary circuit

Remedy: Place power source in a heated room and allow it to warm up

tu3 | xxx

Note: xxx stands for a temperature value

Cause: Undertemperature in the wirefeeder motor

Remedy: Place wirefeeder in a heated room and allow to warm up

tu4 | xxx

Note: xxx stands for a temperature value

Cause: Undertemperature in the welding torch

Remedy: Place welding torch in a heated room and allow to warm up

tu5 | xxx

Note: xxx stands for a temperature value

Cause: Undertemperature in the cooling unit

Remedy: Place cooling unit in a heated room and allow to warm up

tu6 | xxx

Note: xxx stands for a temperature value

Cause: Undertemperature on the power source transformer

Remedy: Place power source in a heated room and allow it to warm up

tu7 | xxx

Note: xxx stands for a temperature value

Cause: Undertemperature in power source

Remedy: Place power source in a heated room and allow it to warm up

no | H2O

Cause: Coolant flow rate too low

Remedy: Check coolant flow rate and cooling unit, including cooling circuit (for minimum coolant flow, see "Technical Data" chapter in the Operating Instructions for the device)

hot | H2O

Cause: The coolant temperature is too high

Remedy: Allow cooling unit and cooling circuit to cool down, until "hot | H2O" is no longer displayed. Open the cooling unit and clean the cooler, check fan is working properly.

no | Prg

Cause: No preconfigured program has been selected

Remedy: Select a configured program

no | IGn

Cause: "Ignition time-out" function is active; current did not start flowing before the length of wire specified in the Setup menu had been fed. The power source safety cut-out has tripped

Remedy: Shorten the wire stick-out; press the torch trigger again; clean the surface of the workpiece; if necessary, set the "Ito" parameter in the Setup menu

EPG | 17

Cause: The selected welding program is invalid

Remedy: Select a valid welding program

EPG | 29

Cause: The required wirefeeder is not available for the selected characteristic

Remedy: Connect the correct wirefeeder, check the plug connections for the hosepack

EPG | 35

Cause: Measurement of the welding circuit resistance failed

Remedy: Check grounding cable, current cable, or hosepack and replace if necessary, re-measure the welding circuit resistance

Displayed service codes in connection with OPT Easy Documentation

no | dAt

Welding is not possible

Cause: Date and time are not set on the power source

Remedy: To reset the service code, press the arrow key;
Set date and time in the 2nd level of the service menu:
see page [97](#)

bAt | Lo

Welding is possible

Cause: The battery of OPT Easy Documentation is low

Remedy: To reset the service code, press the arrow key;
Contact service (to change the battery)

bAt | oFF

Welding is not possible

Cause: The battery of the OPT Easy Documentation is empty

Remedy: To reset the service code, press the arrow key - the display shows no | dAt;
Contact service (to change the battery);
After changing the battery, the date and time in the are displayed in the 2nd level of the service menu:
see page [97](#)

Err | doc

Welding is not possible

Cause: Error writing data;
Internal documentation error;
Communication error;

Remedy: Turn power source off and on again

Err | USb

Welding is not possible

Cause: Invalid file system on USB thumb drive;
General USB error

Remedy: Unplug the USB thumb drive

USB | full

Welding is not possible

Cause: The plugged in USB thumb drive is full

Remedy: Unplug USB thumb drive, plug in new USB thumb drive

Service, maintenance and disposal

General

Under normal operating conditions, the welding system requires only a minimum of care and maintenance. However, several points must be observed in order for the welding system to remain operational for years to come.

Safety

WARNING!

Danger from electrical current.

This can result in serious personal injury and damage to property.

- ▶ Before starting work, switch off all devices and components involved, and disconnect them from the grid.
- ▶ Secure all devices and components involved so they cannot be switched back on.
- ▶ After opening the device, use a suitable measuring instrument to check that electrically charged components (such as capacitors) have been discharged.

WARNING!

Danger from incorrect operation and work that is not carried out properly.

This can result in serious personal injury and damage to property.

- ▶ All the work and functions described in this document must only be carried out by technically trained and qualified personnel.
- ▶ Read and understand this document in full.
- ▶ Read and understand all safety rules and user documentation for this equipment and all system components.

At every start-up

- Check mains plug and mains cable, as well as the welding torch, interconnecting hosepack, and ground earth connection for damage
- Check if the all-round clearance of the device is 0.5 m (1 ft. 8 in.) so that cooling air can circulate unimpeded

NOTE!

Air inlet and outlet openings must not be blocked or even partially covered.

Whenever required

Remove the air filter on the rear of the housing from the side and clean it.

Every 2 Months

CAUTION!

Danger of damage to property.

- ▶ The air filter must only be fitted when dry.
- ▶ If required, clean air filter using dry compressed air or by washing it.

Every 6 Months

 **CAUTION!**

Danger due to the effect of compressed air.

This can result in damage to property.

- ▶ Do not bring the air nozzle too close to electronic parts.
-

- 1** Dismantle device side panels and blow the inside of the device clean with dry, reduced compressed air
- 2** Also clean the cooling air ducts if there is a large accumulation of dust

 **WARNING!**

An electric shock can be fatal.

Danger of electric shock due to grounding cable and device grounding points not being connected properly.

- ▶ When refitting the side panels, ensure that the grounding cable and device grounding points are properly connected.
-

Disposal

Materials should be disposed of according to valid local and national regulations.

Appendix

Average consumption values during welding

Average wire electrode consumption during MIG/MAG welding

Average wire electrode consumption at a wire speed of 5 m/min			
	1.0 mm wire electrode diameter	1.2 mm wire electrode diameter	1.6 mm wire electrode diameter
Steel wire electrode	1.8 kg/h	2.7 kg/h	4.7 kg/h
Aluminum wire electrode	0.6 kg/h	0.9 kg/h	1.6 kg/h
CrNi wire electrode	1.9 kg/h	2.8 kg/h	4.8 kg/h

Average wire electrode consumption at a wire speed of 10 m/min			
	1.0 mm wire electrode diameter	1.2 mm wire electrode diameter	1.6 mm wire electrode diameter
Steel wire electrode	3.7 kg/h	5.3 kg/h	9.5 kg/h
Aluminum wire electrode	1.3 kg/h	1.8 kg/h	3.2 kg/h
CrNi wire electrode	3.8 kg/h	5.4 kg/h	9.6 kg/h

Average shielding gas consumption during MIG/MAG welding

Wire electrode diameter	1.0 mm	1.2 mm	1.6 mm	2.0 mm	2 x 1.2 mm (TWIN)
Average consumption	10 l/min	12 l/min	16 l/min	20 l/min	24 l/min

Average shielding gas consumption during TIG welding

Gas nozzle size	4	5	6	7	8	10
Average consumption	6 l/min	8 l/min	10 l/min	12 l/min	12 l/min	15 l/min

Technical data

Overview with critical raw materials, year of production of the device

Overview with critical raw materials:

An overview of which critical raw materials are contained in this device can be found at the following Internet address.

www.fronius.com/en/about-fronius/sustainability.

To calculate the year of production of the device:

- Each device is provided with a serial number
- The serial number consists of 8 digits - for example 28020099
- The first two digits give the number from which the year of production of the device can be calculated
- This figure minus 11 gives the year of production
 - For example: Serial number = **28**020065, calculation of the year of production = **28** - 11 = 17, year of production = 2017

Special Voltage

For devices designed for special voltages, the technical data on the rating plate applies.

The following applies for all devices with a permitted grid voltage of up to 460 V: The standard mains plug allows the user to operate with a grid voltage of up to 400 V. For grid voltages up to 460 V fit a mains plug permitted for such use or install the mains supply directly.

Explanation of the term duty cycle

The duty cycle (ED) is the period of a ten minute cycle in which the device may be operated at the stated power without overheating.

NOTE!

The ED values cited on the rating plate relate to an ambient temperature of 40 °C.

If the ambient temperature is higher, the ED or power must be lowered accordingly.

Example: Welding with 150 A at 60% ED

- Welding phase = 60% of 10 mins = 6 mins
- Cool-down phase = rest time = 4 mins
- Following the cool-down phase, the cycle begins again.

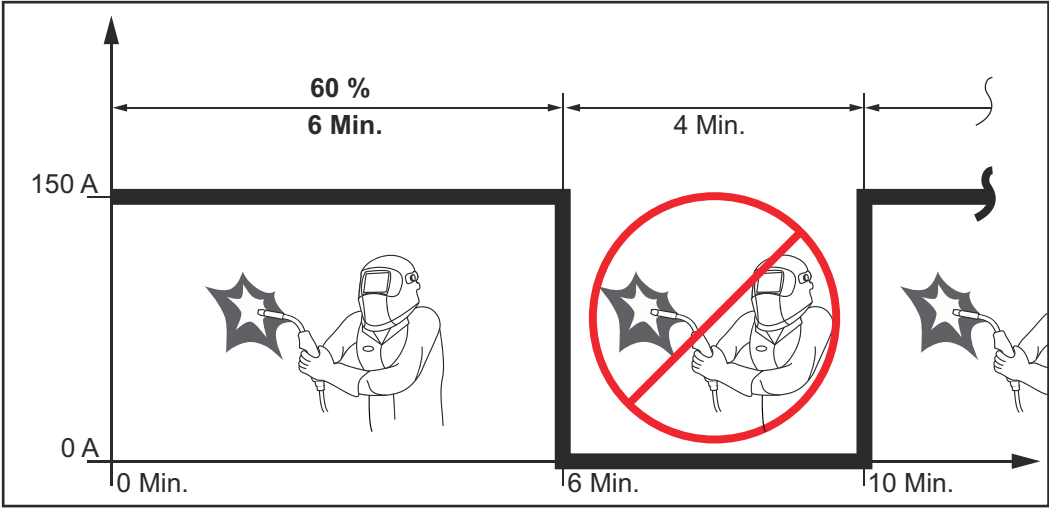

To use the device without interruptions:

- 1 Search for a 100% ED value in the technical data, which corresponds to the existing ambient temperature.
- 2 Reduce the power or amperage value correspondingly so that the device can operate without a cool-down phase.

**TransSteel
3000c Pulse
TransSteel
3000c Pulse nc**

Mains voltage (U_1)	3 x 380 / 400 V, 3 x 460 V
Max. effective primary current ($I_{1\text{eff}}$)	
3 x 380/400 V	14.0 A
3 x 460 V	12.0 A
Max. primary current ($I_{1\text{max}}$)	
3 x 380/400 V	19.0 A
3 x 460 V	16.0 A
Mains fuse	35 A slow-blow
Mains voltage tolerance	-10 / +15%
Mains frequency	50/60 Hz
Cos phi (1)	0.99
Max. permitted grid impedance Z_{max} on PCC ¹⁾	92.2 mOhm
Recommended residual-current circuit breaker	Type B
Welding current range (I_2)	
MIG/MAG	10 - 300 A
TIG	10 - 300 A
MMA	10 - 300 A
Welding current at 10 min / 40 °C (104 °F)	40% / 300 A 60% / 280 A 100% / 240 A
Output voltage range according to standard characteristic (U_2)	
MIG/MAG	14.5 - 29.0 V
TIG	10.4 - 22.0 V
MMA	20.4 - 32.0 V
Open circuit voltage (U_0 peak / U_0 r.m.s)	59 V
Apparent power at 400 V AC	11.8 kVA
Protection class	IP 23
Type of cooling	AF
Insulation class	B
Overvoltage category	III
Pollution degree according to IEC60664	3
EMC emission class	A ²⁾
Safety symbols	S, CE, CSA
Dimensions l x w x h	747 x 300 x 497 mm 29.4 x 11.8 x 19.6 in.
Weight	36 kg / 79.4 lb.

Max. shielding gas pressure	5 bar/72.52 psi
Coolant	Original Fronius
Wire speed	1 - 25 m/min / 40 - 980 ipm
Wire drive	4-roller drive
Wire diameter	0.8 - 1.6 mm/0.03 - 0.06 in.
Wirespool diameter	max. 300 mm / max. 11.81 in.
Wirespool weight	max. 19.0 kg / max. 41.9 lb.
Max. noise emission (L _{WA})	72 dB (A)
Idle state power consumption at 400 V	36.5 W
Power source efficiency at 300 A / 32 V	90%

- 1) Interface to a 230/400-V and 50-Hz public grid
- 2) A device in emissions class A is not intended for use in residential areas in which the power is supplied via a public low-voltage grid.
The electromagnetic compatibility may be influenced by conducted or radiated radio frequencies.

Welding program tables

Welding program label on the device

A label with the most common welding programs is affixed to the power source:

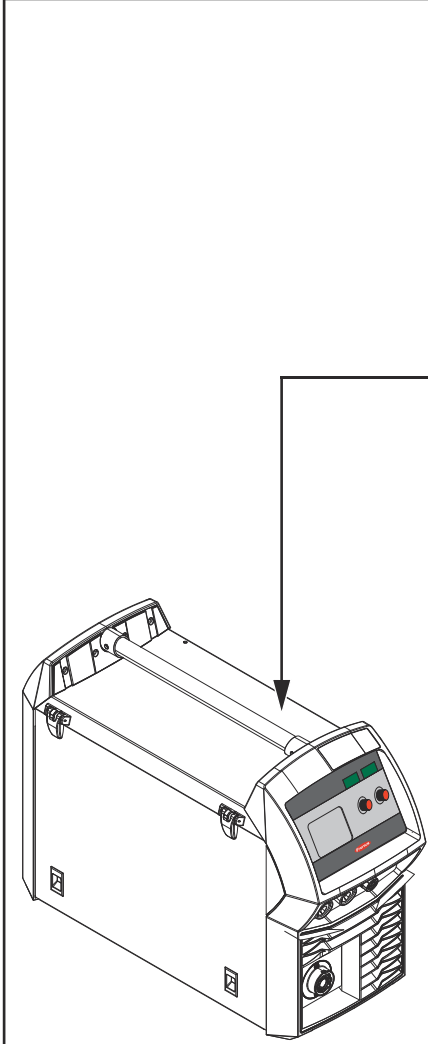

Standard welding characteristics									
Tst - 3000 Pulse KL-DB: 3992		Configuration		Ø (mm / inch)					
				0.8 .030	0.9 .035	1.0 .040	1.2 .045	1.4 .052	1.6 1/16
Steel ER 70-120	CO2 100%	1		A	-	-	-	-	-
Steel ER 70-120	Ar+2-12%CO2	1		B	┘	┘	┘	┘	┘
Steel ER 70-120	Ar+13-25%CO2	1		C	┘	┘	┘	┘	┘
Steel ER 70-120	Ar+2-8%O2	1		D	-	-	-	-	-
CrNi Stainless	Ar+2-12%CO2	2		B	┘	┘	┘	┘	┘
CuSi3 ER CuSi-A	Ar 100%	3		E	┘	┘	┘	┘	┘
AlMg ER5xxx	Ar 100%	4		E	┘	┘	┘	┘	┘
AlSi ER 4xxx	Ar 100%	5		E	┘	┘	┘	┘	┘
Metal Cored	Ar+2-12%CO2	6		B	-	-	┘	-	-
Metal Cored	Ar+13-25%CO2	6		C	-	-	┘	-	-
Self-shielded		7			-	-	-	-	-

Additional welding characteristics									
Tst - 3000 Pulse KL-DB: 3992		SP Configuration		Ø (mm / inch)					
				0.8 .030	0.9 .035	1.0 .040	1.2 .045	1.4 .052	1.6 1/16
CrNi Stainless FCW	Ar+ 15-25%CO2	8		SP	A	-	-	┘	-
CrNi Stainless root	Ar+ 2.5%CO2	8		SP	B	-	-	-	-
Rutil FCW E71T FCW	CO2 100%	8		SP	C	-	-	-	-
Rutil FCW E71T FCW	Ar+ 15-25%CO2	8		SP	D	-	-	┘	-
Basic FCW E70T FCW	CO2 100%	8		SP	E	-	-	-	-
Basic FCW E70T FCW	Ar+ 15-25%CO2	8		SP	F	-	-	┘	-
Steel dyn ER70-120	Ar+ 8-10%CO2	1		SP	F	-	-	-	-
Steel dyn ER70-120	Ar+ 15-25%CO2	2		SP	F	-	-	-	-
Steel dyn ER70-120	Ar+ 4%O2	3		SP	F	-	-	-	-
Steel root	CO2 100%	4		SP	F	-	-	-	-
Steel root / PCS	Ar+ 8-10%CO2	5		SP	F	-	-	┘	┘
Steel root / PCS	Ar+ 15-25%CO2	6		SP	F	-	-	┘	┘

42,0409,0729 - Standard ┘ Pulse























Welding program label on the power source

























































Welding program tables for TransSteel 3000c Pulse

1	Steel/ER 70-120	inch	mm		
2	CrNi/Stainless	.030	0,8		
3	CuSi/ER CuSi-A	.035	0,9	CO ₂ 100%	A
4	AlMg/ER 5xxx	.040	1,0	Ar + 2-12% CO ₂	B
5	AlSi/ER 4xxx	.045	1,2	Ar + 13-25% CO ₂	C
6	Metal Cored	.052	1,4	Ar + 2-8% O ₂	D
7	Self-shielded	1/16	1,6	Ar 100%	E
8	SP	SP	SP	SP	F

The welding programs are active if the "SEt" setup parameter is set to "Std" (Standard)

Welding program database: DB 3992

Standard welding characteristics										
Material	Gas	Configuration		Diameter						
				0,8 mm .030"	0,9 mm .035"	1,0 mm .040"	1,2 mm .045"	1,4 mm .052"	1,6 mm 1/16"	SP
Steel/ER70-120	CO ₂ 100%	1 	 A	S2290	S2300	S2310	S2322			
Steel/ER70-120	Ar + 2-12% CO ₂	1 	 B	S2288 P4000	S2298 P4001	S2308 P3977	S2324 P3979			
Steel/ER70-120	Ar + 13-25% CO ₂	1 	 C	S2485 P4006	S2486 P3990	S2487 P3958	S2488 P3987			
Steel/ER70-120	Ar + 2-8% O ₂	1 	 D	S2285	S2297	S2307	S2323			
CrNi/Stainless	Ar + 2-12% CO ₂	2 	 B	S2427 P3969	S2402 P3970	S2426 P3968	S2405 P3966			
CuSi/ER-CuSi-A	Ar 100%	3 	 E	S2496 P3973	S2495 P3974	S2493 P3976	S2497 P3975			
AlMg/ER 5xxx	Ar 100%	4 	 E	P3955	P3956	S3639 P3954	S3643 P3953			
AlSi/ER 4xxx	Ar 100%	5 	 E		P4048	S3640 P3961	S3092 P3960			
Metall Cored	Ar + 2-12% CO ₂	6 	 B		S2420		S2385 P3980			
Metall Cored	Ar + 13-25% CO ₂	6 	 C		S2421		S2536 P3983			
Self-shielded	(no Gas)	7 			S2350		S2349			

Additional welding characteristics											
Material	Gas	Configuration		Diameter							
				0,8 mm .030"	0,9 mm .035"	1,0 mm .040"	1,2 mm .045"	1,4 mm .052"	1,6 mm 1/16"	SP	
CrNi/Stainless FCW	Ar + 18% CO ₂	8 	SP 		A		S2423 P4014		S2424 P4013		
CrNi/Stainless root	Ar + 18% CO ₂	8 	SP 		A	S2440	S2441	S2442	S2443		
Rutil FCW/E71T FCW	CO ₂ 100%	8 	SP 		C		S2471		S2472		
Rutil FCW/E71T FCW	Ar + 18% CO ₂	8 	SP 		D		S2411 P4065		S2320 P4007		
Basic FCW/E70T FCW	CO ₂ 100%	8 	SP 		E				S2474		
Basic FCW/E70T FCW	Ar + 25% CO ₂	8 	SP 		F				S2473 P4011		
Steel dyn/ER70-120	Ar + 8% CO ₂	1 		SP 	F	S2292	S2302	S2312	S2326		
Steel dyn/ER70-120	Ar + 18% CO ₂	2 		SP 	F	S2293	S2303	S2313	S2327		
Steel dyn/ER70-120	Ar + 4% CO ₂	3 		SP 	F	S2291	S2301	S2311	S2325		
Steel/root	CO ₂ 100%	4 		SP 	F	S2502	S2501	S2499	S2500		
Steel/root PCS	Ar + 8% CO ₂	5 		SP 	F	S3962	S2305 P3997	S2315 P3978	S2329 P3986		
Steel/root PCS	Ar + 18% CO ₂	6 		SP 	F	S4017	S2306 P3993	S2316 P3967	S2330 P3989		
Steel/root	Ar + 4% O ₂	8 		SP 	F	S2294	S2304	S2314			S2328 (1)
CrNi/Stainless	Ar + 90He + 2,5% CO ₂	2 			A						S2404 (2)
CrNi/Stainless	Ar + 90He + 2,5% CO ₂	2 			B						S2407 (1)
CrNi/Stainless	Ar + 33He + 1% CO ₂	2 			C						S2403 (2)
CrNi/Stainless	Ar + 33He + 1% CO ₂	2 			D						S2406 (1)
MAP409Ti FCW	Ar + 2% O ₂	2 			E						S2464 (1)























(1) d = 1.2 mm (2) d = 0.9 mm







































Welding program tables for TransSteel 3000c Pulse - US

1	Steel/ER 70-120	inch	mm		
2	CrNi/Stainless	.030	0,8		
3	CuSi/ER CuSi-A	.035	0,9	CO ₂ 100%	A
4	AlMg/ER 5xxx	.040	1,0	Ar + 2-12% CO ₂	B
5	AlSi/ER 4xxx	.045	1,2	Ar + 13-25% CO ₂	C
6	Metal Cored	.052	1,4	Ar + 2-8% O ₂	D
7	Self-shielded	1/16	1,6	Ar 100%	E
8	SP	SP	SP	SP	F

The welding programs are active if the "SEt" setup parameter is set to "US" (USA).

Welding program database: UID 3992

Standard welding characteristics										
Material	Gas	Configuration		Diameter						SP
				0,8 mm .030"	0,9 mm .035"	1,0 mm .040"	1,2 mm .045"	1,4 mm .052"	1,6 mm 1/16"	
Steel/ER70-120	CO ₂ 100%	1 	 A	S2290	S2300	S2310	S2322			
Steel/ER70-120	Ar + 2-12% CO ₂	1 	 B	S2418 P4000	S2370 P4001	S2308 P3977	S2377 P3979			
Steel/ER70-120	Ar + 13-25% CO ₂	1 	 C	S2419 P4006	S2369 P3990	S2309 P3958	S2376 P3987			
Steel/ER70-120	Ar + 2-8% O ₂	1 	 D	S2285	S2297	S2307				
CrNi/Stainless	Ar + 2-12% CO ₂	2 	 B	S2427 P3969	S2402 P3970	S2426 P3968	S2405 P3966			
CuSi/ER-CuSi-A	Ar 100%	3 	 E	S2496 P3973	S2495 P3974	S2493 P3976	S2497 P3975			
AlMg/ER 5xxx	Ar 100%	4 	 E	P3955	P3956	S3639 P3954	S3643 P3953			
AlSi/ER 4xxx	Ar 100%	5 	 E		P4048	S3640 P3961	S3092 P3960			
Metall Cored	Ar + 2-12% CO ₂	6 	 B		S2420		S2385 P3980			
Metall Cored	Ar + 13-25% CO ₂	6 	 C				S2386 P3983			
Self-shielded	(no Gas)	7 			S2350		S2349			

Additional welding characteristics										
Material	Gas	Configuration		∅ Diameter						
				0,8 mm .030"	0,9 mm .035"	1,0 mm .040"	1,2 mm .045"	1,4 mm .052"	1,6 mm 1/16"	SP
CrNi/Stainless FCW	Ar + 15-25% CO ₂	8 	SP 		S2423 P4014		S2424 P4013			
CrNi/Stainless root	Ar + 2,5% CO ₂	8 	SP 		S2440	S2441	S2442	S2443		
Rutil FCW/E71T FCW	CO ₂ 100%	8 	SP 			S2471		S2472		
Rutil FCW/E71T FCW	Ar + 15-25% CO ₂	8 	SP 		S2470 P4065		S2456 P4007			
Basic FCW/E70T FCW	CO ₂ 100%	8 	SP 				S2474		S2476	
Basic FCW/E70T FCW	Ar + 15-25% CO ₂	8 	SP 				S2473 P4011			
Steel dyn/ER70-120	Ar + 8-10% CO ₂	1 	SP 		S2374	S2367	S2312	S2380		
Steel dyn/ER70-120	Ar + 15-25% CO ₂	2 	SP 		S2375	S2366	S2313	S2379		
Steel dyn/ER70-120	Ar + 4% O ₂	3 	SP 		S2291	S2301	S2311	S2325		
Steel/root	CO ₂ 100%	4 	SP 		S2502	S2501	S2499	S2500		
Steel/root PCS	Ar + 8-10% CO ₂	5 	SP 		S2295	S2364 P3997	S2315 P3978	S2383 P3986		
Steel/root PCS	Ar + 15-25% CO ₂	6 	SP 		S3962	S2363 P3993	S2316 P3967	S2382 P3989		
Steel/root	Ar + 4% O ₂	8 	SP 		S4017	S2304	S2314			S2328 (1)
CrNi/Stainless	Ar + 90He + 2,5% CO ₂	2 								S2404 (2)
CrNi/Stainless	Ar + 90He + 2,5% CO ₂	2 								S2407 (1)
CrNi/Stainless	Ar + 33He + 1% CO ₂	2 								S2403 (2)
CrNi/Stainless	Ar + 33He + 1% CO ₂	2 								S2406 (1)
MAP409Ti FCW	Ar + 2% O ₂	2 								S2464 (1)

(1) d = 1.2 mm (2) d = 0.9 mm



Fronius International GmbH

Froniusstraße 1
4643 Pettenbach
Austria
contact@fronius.com
www.fronius.com

Under www.fronius.com/contact you will find the addresses
of all Fronius Sales & Service Partners and locations.